

FAIRHURST

General

- Specified Site
- Specified Buffer(s)
- Bearing Reference Point

Risk of Flooding from Surface Water

- High - 30 Year Return
- Medium - 100 Year Return
- Low - 1000 Year Return

Suitability

- See the suitability map below
- National to county
 - County to town
 - Town to street
 - Street to parcels of land
 - Property

EANRW Suitability Map - Slice A

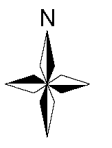
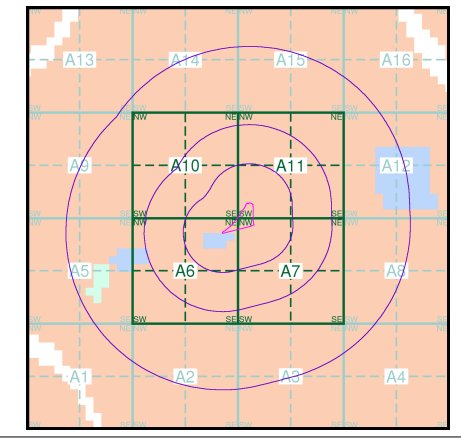

Order Details

Order Number: 142584674_1_1
 Customer Ref: Homebase, Richmond
 National Grid Reference: 518890, 175430
 Slice: A
 Site Area (Ha): 1.58
 Search Buffer (m): 1000

Site Details

Homebase Ltd, 84, Manor Road, RICHMOND, TW9 1YB



Tel: 0844 844 9952
 Fax: 0844 844 9951
 Web: www.envirocheck.co.uk

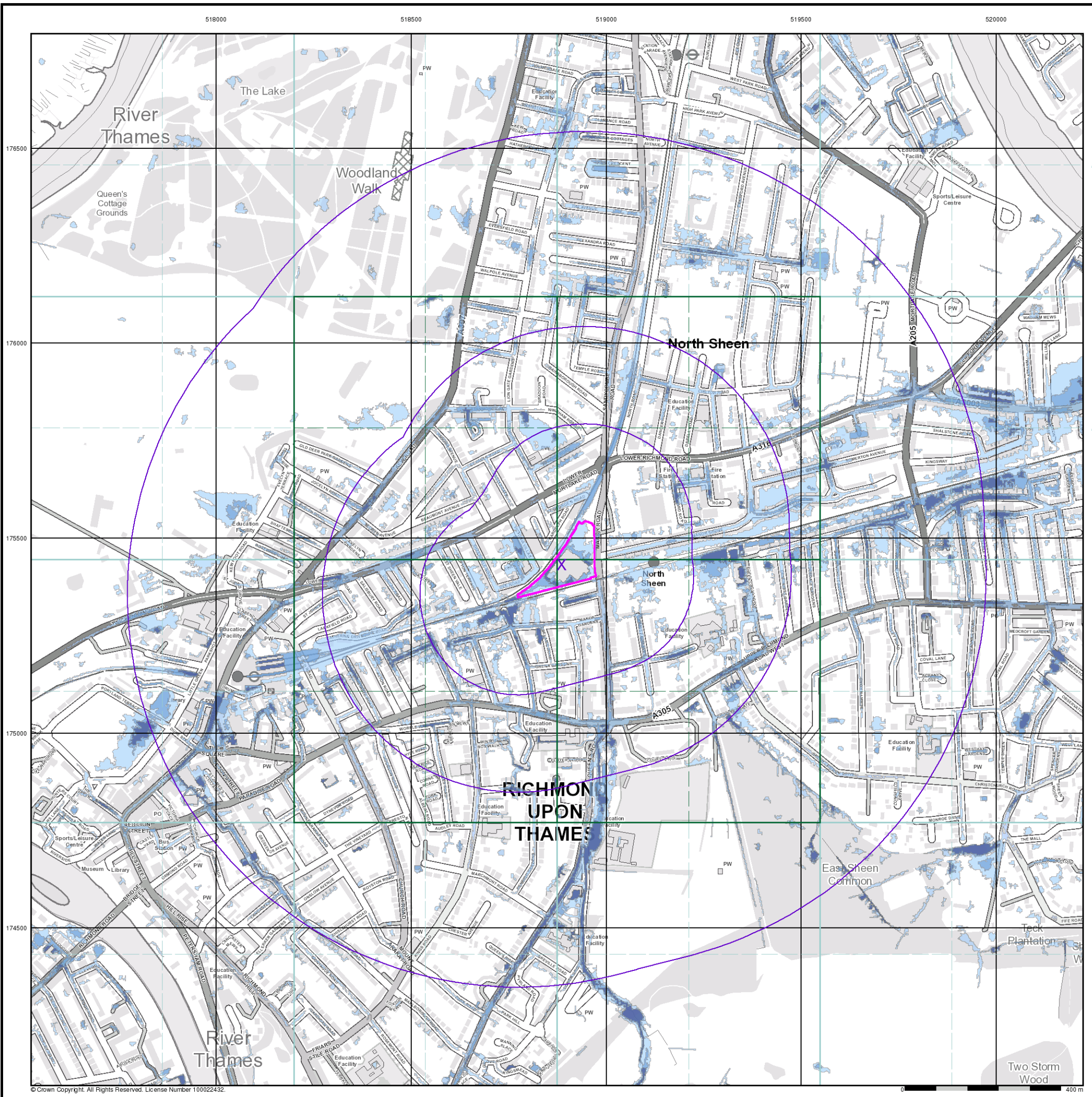

© Crown Copyright. All Rights Reserved. License Number 100022432.

FAIRHURST

General

- Specified Site
- Specified Buffer(s)
- Bearing Reference Point

Urban Soil Chemistry Arsenic

BGS Urban Soil Chemistry Measured Concentration Values (mg/kg)

Arsenic Concentrations mg/kg

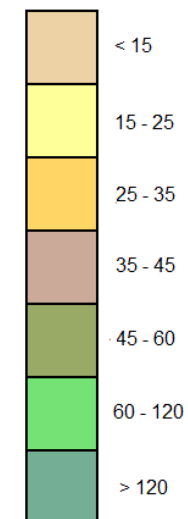

Urban Soil Chemistry Arsenic - Slice A

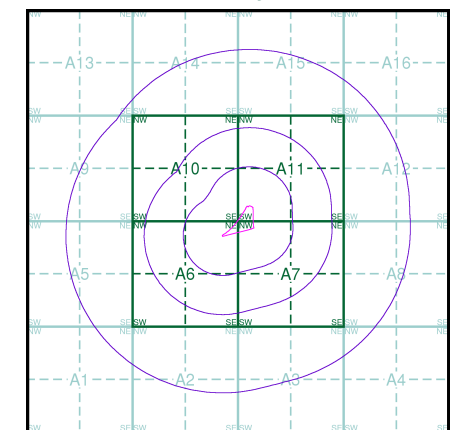

Order Details

Order Details: 142584674_1_1
 Customer Ref: Homebase, Richmond
 National Grid Reference: 518890, 175430
 Slice: A
 Site Area (Ha): 1.58
 Search Buffer (m): 1000

Site Details

Homebase Ltd, 84, Manor Road, RICHMOND, TW9 1YB

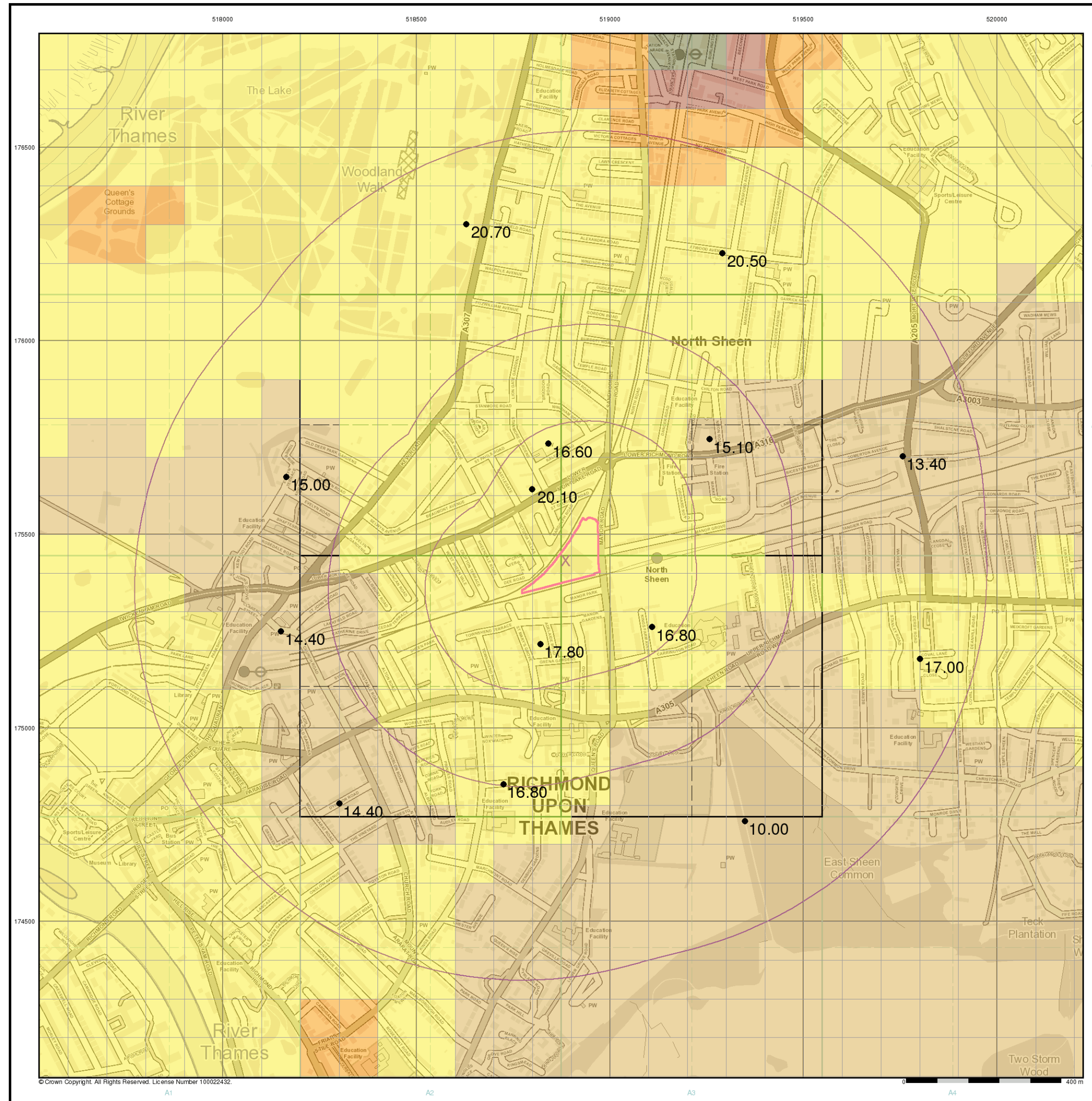

© Crown Copyright. All Rights Reserved. License Number 100022432.

FAIRHURST

General

- Specified Site
- Specified Buffer(s)
- Bearing Reference Point

Urban Soil Chemistry Cadmium

● BGS Urban Soil Chemistry Measured Concentration Values (mg/kg)

Cadmium Concentrations mg/kg

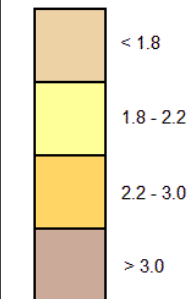

Urban Soil Chemistry Cadmium - Slice A

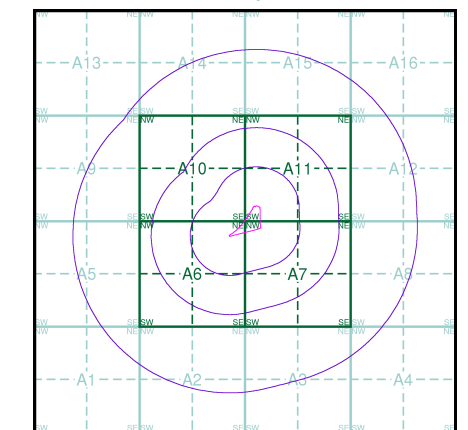

Order Details

Order Details: 142584674_1_1
 Customer Ref: Homebase, Richmond
 National Grid Reference: 518890, 175430
 Slice: A
 Site Area (Ha): 1.58
 Search Buffer (m): 1000

Site Details

Homebase Ltd, 84, Manor Road, RICHMOND, TW9 1YB

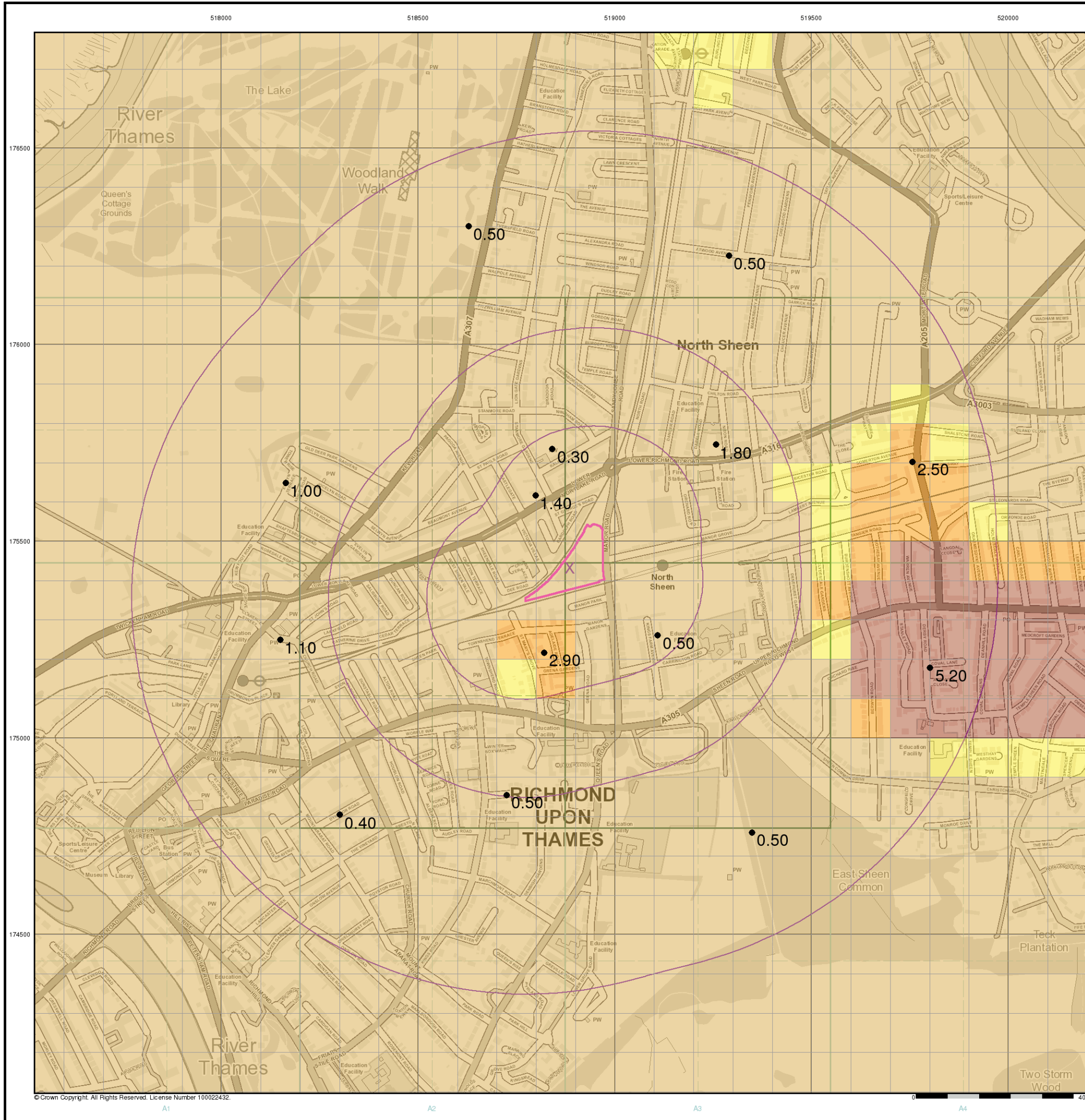

FAIRHURST

General

- Specified Site
- Specified Buffer(s)
- X Bearing Reference Point

Urban Soil Chemistry Chromium

● BGS Urban Soil Chemistry Measured Concentration Values (mg/kg)

Chromium Concentrations mg/kg

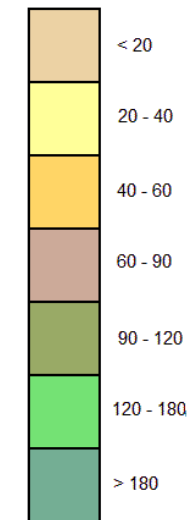

Urban Soil Chemistry Chromium - Slice A

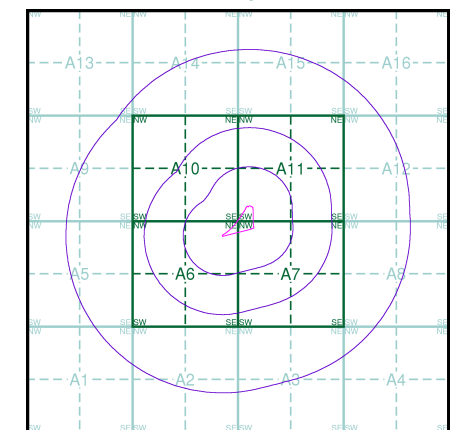

Order Details

Order Details: 142584674_1_1
 Customer Ref: Homebase, Richmond
 National Grid Reference: 518890, 175430
 Slice: A
 Site Area (Ha): 1.58
 Search Buffer (m): 1000

Site Details

Homebase Ltd, 84, Manor Road, RICHMOND, TW9 1YB

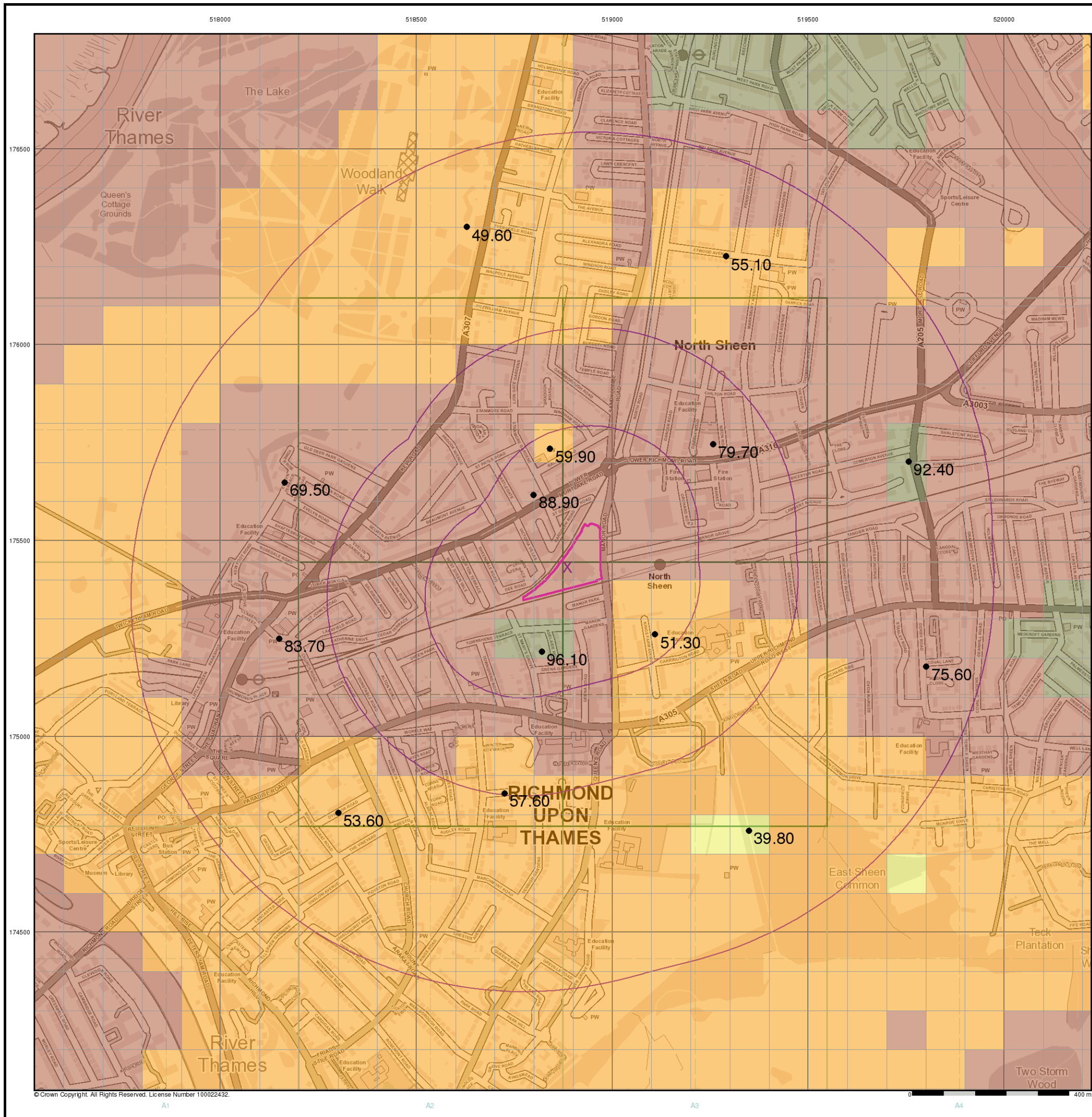

FAIRHURST

General

- Specified Site
- Specified Buffer(s)
- Bearing Reference Point

Urban Soil Chemistry Lead

● BGS Urban Soil Chemistry Measured Concentration Values (mg/kg)

Lead Concentrations mg/kg

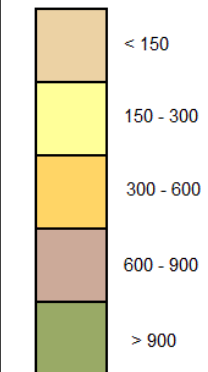

Urban Soil Chemistry Lead - Slice A

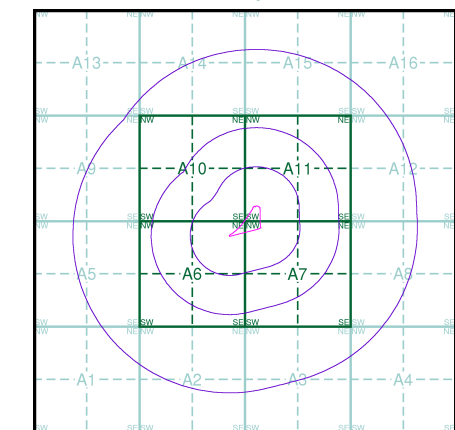

Order Details

Order Details: 142584674_1_1
 Customer Ref: Homebase, Richmond
 National Grid Reference: 518890, 175430
 Slice: A
 Site Area (Ha): 1.58
 Search Buffer (m): 1000

Site Details

Homebase Ltd, 84, Manor Road, RICHMOND, TW9 1YB

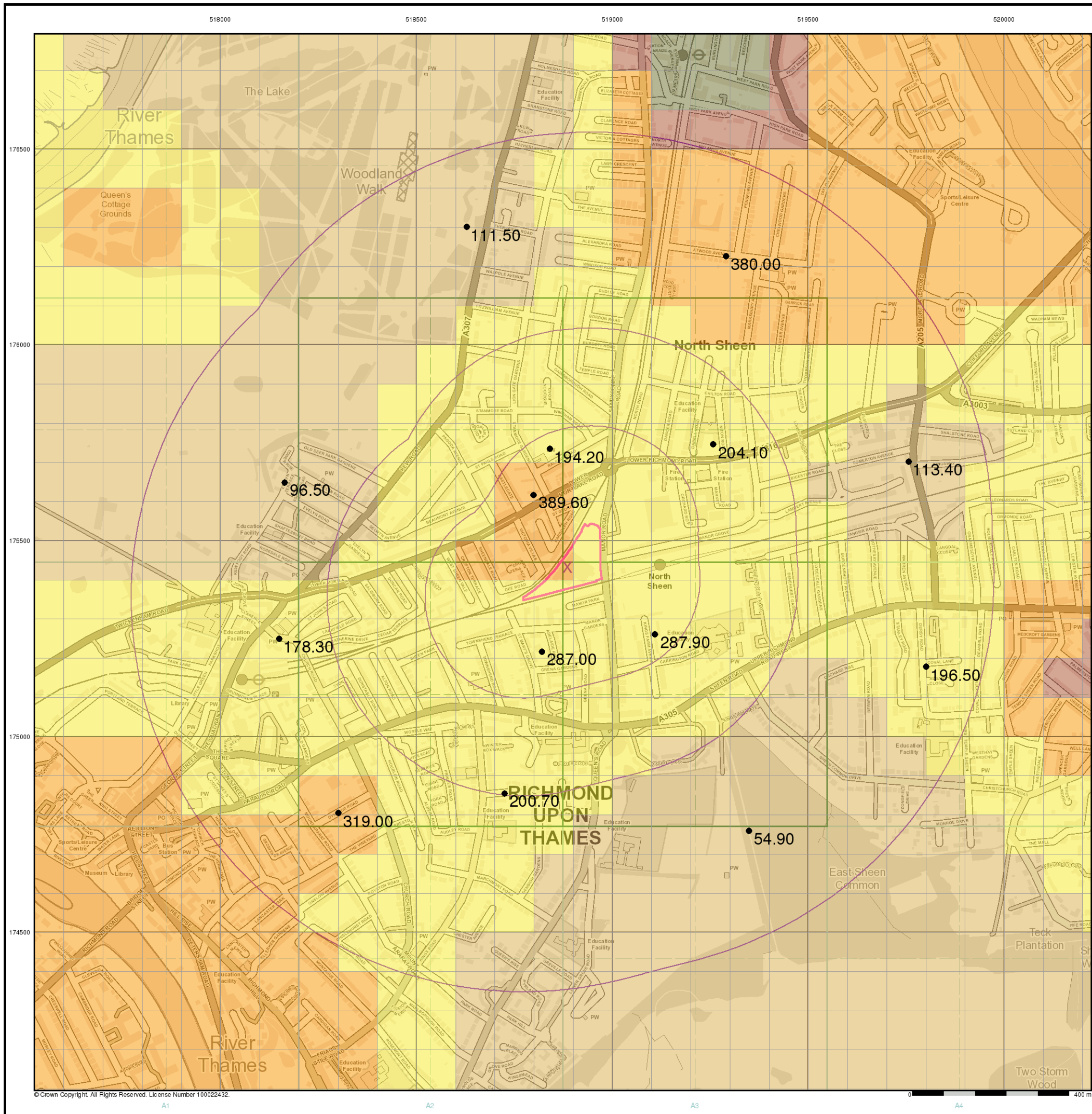

© Crown Copyright. All Rights Reserved. License Number 100022432.

FAIRHURST

General

- Specified Site
- Specified Buffer(s)
- Bearing Reference Point

Urban Soil Chemistry Nickel

● BGS Urban Soil Chemistry Measured Concentration Values (mg/kg)

Nickel Concentrations mg/kg

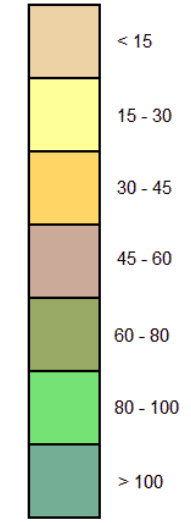

Urban Soil Chemistry Nickel - Slice A

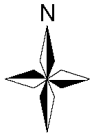
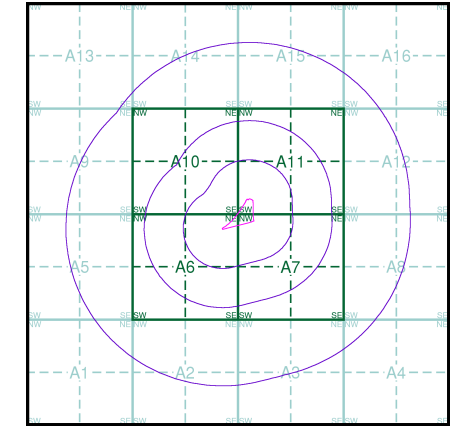

Order Details

Order Details: 142584674_1_1
 Customer Ref: Homebase, Richmond
 National Grid Reference: 518890, 175430
 Slice: A
 Site Area (Ha): 1.58
 Search Buffer (m): 1000

Site Details

Homebase Ltd, 84, Manor Road, RICHMOND, TW9 1YB



Tel: 0844 844 9952
 Fax: 0844 844 9951
 Web: www.envirocheck.co.uk

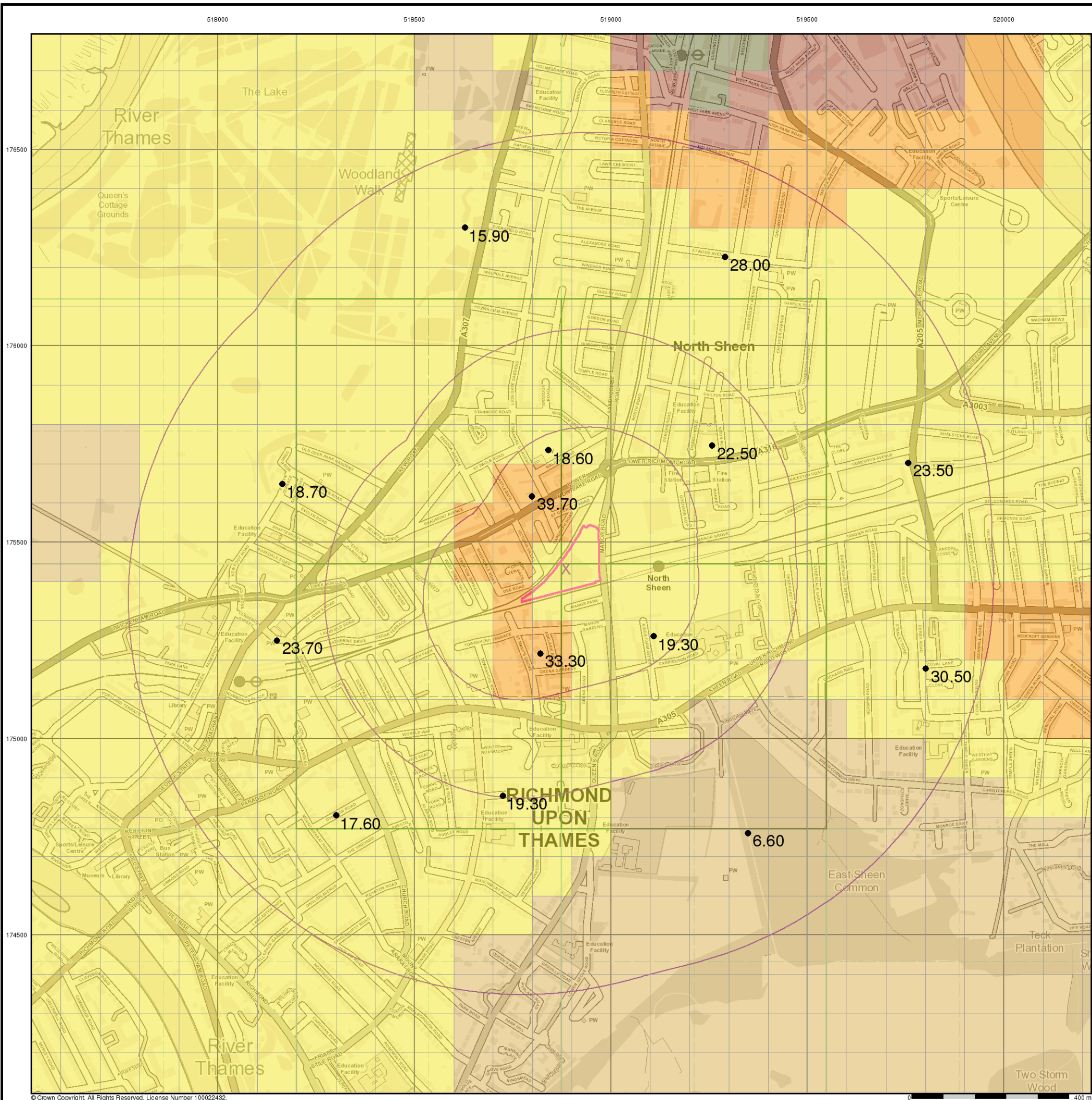

© Crown Copyright. All Rights Reserved. License Number 100022432.

Historical Mapping Legends

Ordnance Survey County Series and Ordnance Survey Plan 1:2,500

Quarry **Gravel Pit** **Sand Pit**
Clay Pit **Shingle** **Refuse Heap**
Sloping Masonry **Flat Rock**
Marsh **Reeds** **Osiers**
Rough Pasture **Furze** **Wood**
Mixed Wood **Brushwood** **Orchard**
Fir **Ford** **Stepping Stones**
Ferry **Waterfall** **Lock**
Trig. Station **Altitude at Trig. Station**
B.M. 325.9 **Bench Mark** **Surface Level**
Arrow denotes flow of water **Antiquities (site of)**
Cutting **Embankment**
Railway crossing Road **Level Crossing** **Road crossing Railway**
Railway crossing River or Canal **Road over single stream** **Road over River or Canal**
County Boundary (Geographical)
County & Civil Parish Boundary
Administrative County & Civil Parish Boundary
County Borough Boundary (England)
Co. Boro. Bdy.
County Burgh Boundary (Scotland)
Co. Burgh Bdy.
BP BS Boundary Post or Stone **P.C.B** Police Call Box
B.R. Bridle Road **P** Pump
E.P Electricity Pylon **S.P** Signal Post
F.B. Foot Bridge **Sl** Sluice
F.P. Foot Path **Sp.** Spring
G.P Guide Post or Board **T.C.B** Telephone Call Box
M.S Mile Stone **Tr.** Trough
M.P M.R Mooring Post or Ring **W** Well

Ordnance Survey Plan, Additional SIMs and Supply of Unpublished Survey Information 1:2,500 and 1:1,250

Inactive Quarry, Chalk Pit or Clay Pit **Active Quarry, Chalk Pit or Clay Pit**
Rock **Boulders**
Cliff **Slopes** **Top**
Roofed Building **Glazed Roof Building**
Sloping Masonry **Archway**
Non-Coniferous Tree (surveyed) **Coniferous Tree (surveyed)**
Non-Coniferous Trees (not surveyed) **Coniferous Trees (not surveyed)**
Orchard Tree **Scrub** **Bracken**
Coppice, Osier **Reeds** **Marsh, Saltings**
Rough Grassland **Heath** **Culvert**
Direction of water flow **Bench Mark** **Antiquity (site of)**
Cave Entrance **Triangulation Station** **Electricity Pylon**
Electricity Transmission Line
County Boundary (Geographical)
County & Civil Parish Boundary
Civil Parish Boundary
Admin. County or County Bor. Boundary
London Borough Boundary
Symbol marking point where boundary mereing changes
BH Beer House **P** Pillar, Pole or Post
BP, BS Boundary Post or Stone **PO** Post Office
Cn, C Capstan, Crane **PC** Public Convenience
Chy Chimney **PH** Public House
D Fn Drinking Fountain **Pp** Pump
EI P Electricity Pillar or Post **SB, S Br** Signal Box or Bridge
FAP Fire Alarm Pillar **SP, SL** Signal Post or Light
FB Foot Bridge **Spr** Spring
GP Guide Post **Tk** Tank or Track
H Hydrant or Hydraulic **TCB** Telephone Call Box
LC Level Crossing **TCP** Telephone Call Post
MH Manhole **Tr** Trough
MP Mile Post or Mooring Post **Wr Pt, Wr T** Water Point, Water Tap
MS Mile Stone **W** Well
NTL Normal Tidal Limit **Wd Pp** Wind Pump

Large-Scale National Grid Data 1:2,500 and 1:1,250

Cliff **Slopes** **Top**
Rock **Rock (scattered)**
Boulders **Boulders (scattered)**
Positioned Boulder **Scree**
Non-Coniferous Tree (surveyed) **Coniferous Tree (surveyed)**
Non-Coniferous Trees (not surveyed) **Coniferous Trees (not surveyed)**
Orchard Tree **Scrub** **Bracken**
Coppice, Osier **Reeds** **Marsh, Saltings**
Rough Grassland **Heath** **Culvert**
Direction of water flow **Triangulation Station** **Antiquity (site of)**
Electricity Transmission Line **Electricity Pylon**
B.M. 231.60m Bench Mark **Buildings with Building Seed**
Roofed Building **Glazed Roof Building**
Civil parish/community boundary
District boundary
County boundary
Boundary post/stone
Boundary mereing symbol (note: these always appear in opposed pairs or groups of three)
Bks Barracks **P** Pillar, Pole or Post
Bty Battery **PO** Post Office
Cemy Cemetery **PC** Public Convenience
Chy Chimney **Pp** Pump
Cis Cistern **Ppg Sta** Pumping Station
Dismtd Rly Dismantled Railway **PW** Place of Worship
EI Gen Sta Electricity Generating Station **Sewage Ppg Sta** Sewage Pumping Station
EI P Electricity Pole, Pillar **SB, S Br** Signal Box or Bridge
EI Sub Sta Electricity Sub Station **SP, SL** Signal Post or Light
FB Filter Bed **Spr** Spring
Fn / D Fn Fountain / Drinking Ftn. **Tk** Tank or Track
Gas Gov Gas Valve Compound **Tr** Trough
GVC Gas Governor **Wd Pp** Wind Pump
GP Guide Post **Wr Pt, Wr T** Water Point, Water Tap
MH Manhole **Wks** Works (building or area)
MP, MS Mile Post or Mile Stone **W** Well

FAIRHURST

Historical Mapping & Photography included:

Mapping Type	Scale	Date	Pg
Surrey	1:2,500	1868 - 1894	2
Surrey	1:2,500	1868	3
Surrey	1:2,500	1868	4
Middlesex	1:2,500	1871	5
London	1:2,500	1896	6
Surrey	1:2,500	1898	7
Surrey	1:2,500	1913	8
Middlesex	1:2,500	1915	9
Surrey	1:2,500	1934 - 1936	10
Middlesex	1:2,500	1935	11
Historical Aerial Photography	1:1,250	1946 - 1947	12
Ordnance Survey Plan	1:2,500	1960 - 1961	13
Ordnance Survey Plan	1:1,250	1960	14
Additional SIMs	1:2,500	1960 - 1961	15
Additional SIMs	1:1,250	1960 - 1980	16
Ordnance Survey Plan	1:1,250	1968 - 1974	17
Additional SIMs	1:1,250	1973 - 1988	18
Supply of Unpublished Survey Information	1:1,250	1974	19
Additional SIMs	1:1,250	1983	20
Additional SIMs	1:1,250	1989	21
Large-Scale National Grid Data	1:1,250	1991	22
Large-Scale National Grid Data	1:1,250	1992 - 1994	23
Historical Aerial Photography	1:2,500	1999	24

Historical Map - Segment A11

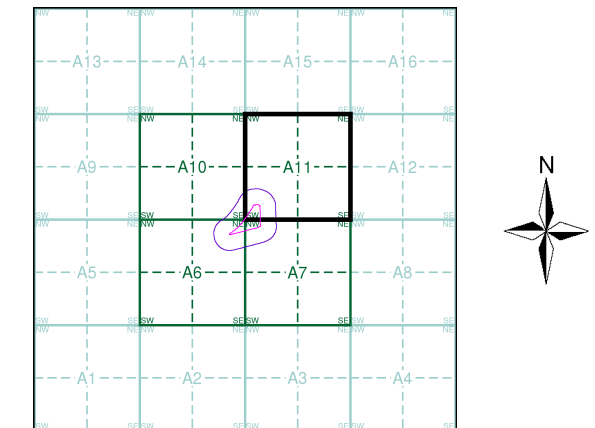

Order Details

Order Number: 142584674_1_1
 Customer Ref: Homebase, Richmond
 National Grid Reference: 518890, 175430
 Slice: A
 Site Area (Ha): 1.58
 Search Buffer (m): 100

Site Details

Homebase Ltd, 84, Manor Road, RICHMOND, TW9 1YB

Landmark
 INFORMATION GROUP

Tel: 0844 844 9952
 Fax: 0844 844 9951
 Web: www.envirocheck.co.uk

FAIRHURST

Surrey

Published 1868 - 1894

Source map scale - 1:2,500

The historical maps shown were reproduced from maps predominantly held at the scale adopted for England, Wales and Scotland in the 1840's. In 1854 the 1:2,500 scale was adopted for mapping urban areas and by 1896 it covered the whole of what were considered to be the cultivated parts of Great Britain. The published date given below is often some years later than the surveyed date. Before 1938, all OS maps were based on the Cassini Projection, with independent surveys of a single county or group of counties, giving rise to significant inaccuracies in outlying areas.

Map Name(s) and Date(s)

001_16 1894 1:2,500	002_13 1868 1:2,500
006_04 1879 1:2,500	007_01 1869 1:2,500

Historical Map - Segment A11

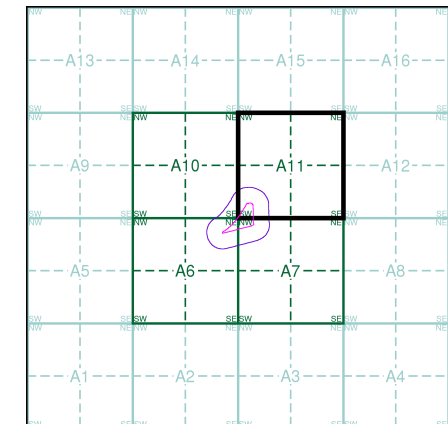

Order Details

Order Number: 142584674_1_1
Customer Ref: Homebase, Richmond
National Grid Reference: 518890, 175430
Slice: A
Site Area (Ha): 1.58
Search Buffer (m): 100

Site Details

Homebase Ltd, 84, Manor Road, RICHMOND, TW9 1YB

Landmark
INFORMATION GROUP

Tel: 0844 844 9952
Fax: 0844 844 9951
Web: www.envirocheck.co.uk

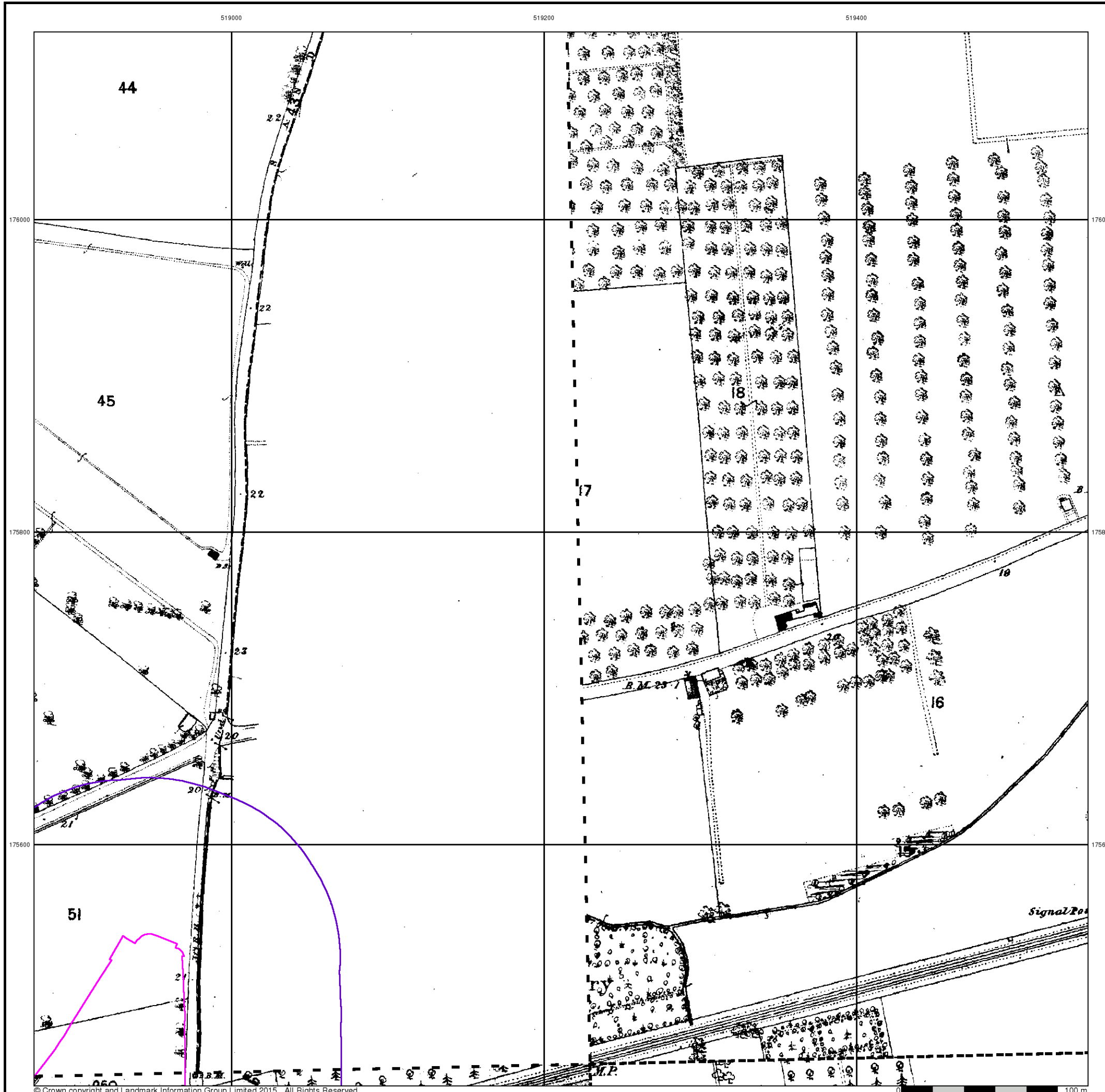

519000

519200

519400

176000

176000

175800

175800

175600

175600

FAIRHURST

Surrey

Published 1868

Source map scale - 1:2,500

The historical maps shown were reproduced from maps predominantly held at the scale adopted for England, Wales and Scotland in the 1840's. In 1854 the 1:2,500 scale was adopted for mapping urban areas and by 1896 it covered the whole of what were considered to be the cultivated parts of Great Britain. The published date given below is often some years later than the surveyed date. Before 1938, all OS maps were based on the Cassini Projection, with independent surveys of a single county or group of counties, giving rise to significant inaccuracies in outlying areas.

Map Name(s) and Date(s)

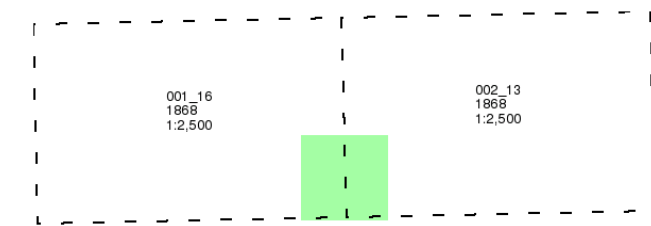

Historical Map - Segment A11

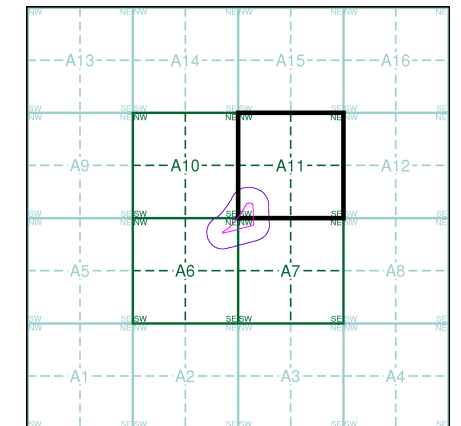

Order Details

Order Number: 142584674_1_1
Customer Ref: Homebase, Richmond
National Grid Reference: 518890, 175430
Slice: A
Site Area (Ha): 1.58
Search Buffer (m): 100

Site Details

Homebase Ltd, 84, Manor Road, RICHMOND, TW9 1YB

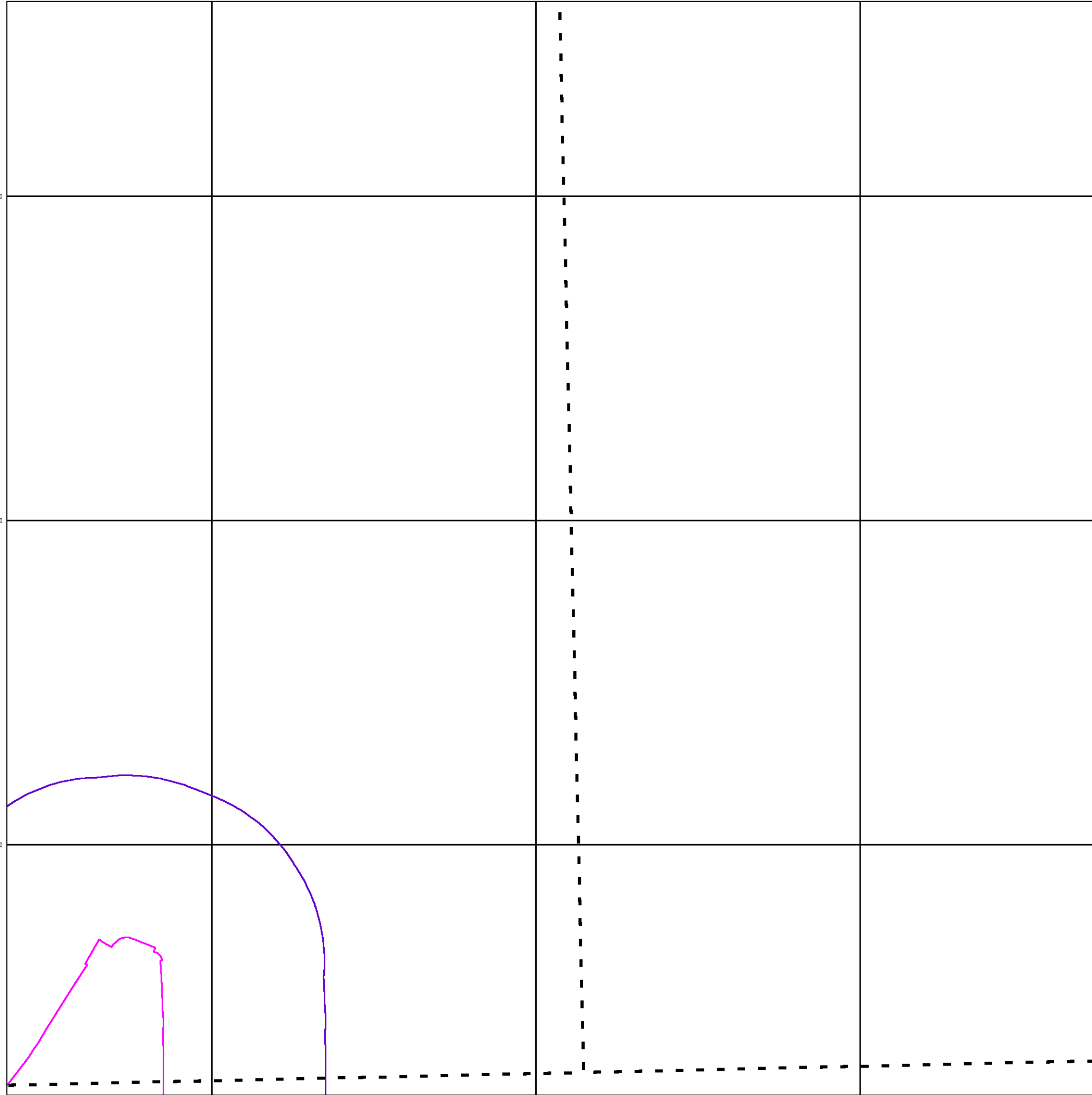

FAIRHURST

Surrey

Published 1868

Source map scale - 1:2,500

The historical maps shown were reproduced from maps predominantly held at the scale adopted for England, Wales and Scotland in the 1840's. In 1854 the 1:2,500 scale was adopted for mapping urban areas and by 1896 it covered the whole of what were considered to be the cultivated parts of Great Britain. The published date given below is often some years later than the surveyed date. Before 1938, all OS maps were based on the Cassini Projection, with independent surveys of a single county or group of counties, giving rise to significant inaccuracies in outlying areas.

Map Name(s) and Date(s)

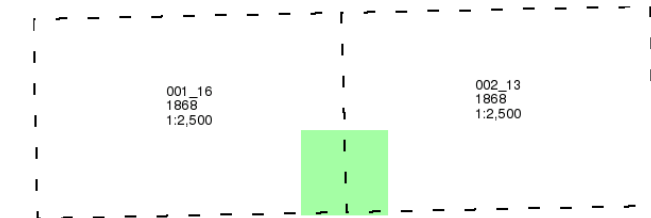

Historical Map - Segment A11

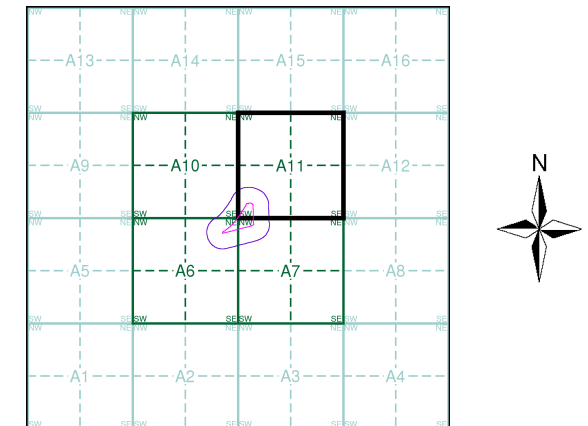

Order Details

Order Number: 142584674_1_1
Customer Ref: Homebase, Richmond
National Grid Reference: 518890, 175430
Slice: A
Site Area (Ha): 1.58
Search Buffer (m): 100

Site Details

Homebase Ltd, 84, Manor Road, RICHMOND, TW9 1YB

Landmark
INFORMATION GROUP

Tel: 0844 844 9952
Fax: 0844 844 9951
Web: www.envirocheck.co.uk



519000

519200

519400

FAIRHURST

Middlesex

Published 1871

Source map scale - 1:2,500

The historical maps shown were reproduced from maps predominantly held at the scale adopted for England, Wales and Scotland in the 1840's. In 1854 the 1:2,500 scale was adopted for mapping urban areas and by 1896 it covered the whole of what were considered to be the cultivated parts of Great Britain. The published date given below is often some years later than the surveyed date. Before 1938, all OS maps were based on the Cassini Projection, with independent surveys of a single county or group of counties, giving rise to significant inaccuracies in outlying areas.

Map Name(s) and Date(s)

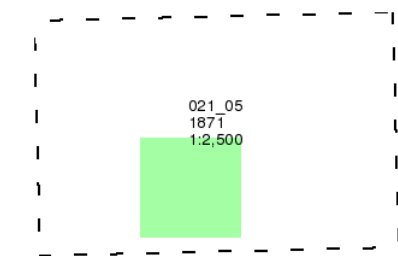

Historical Map - Segment A11

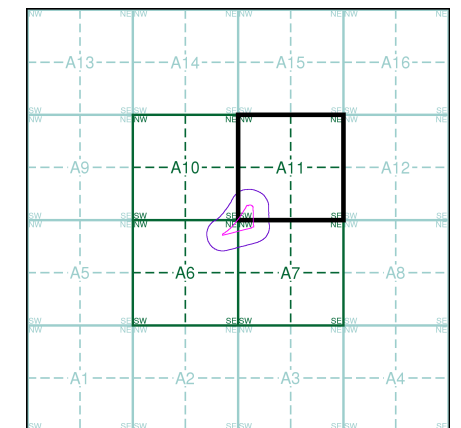

Order Details

Order Number: 142584674_1_1
Customer Ref: Homebase, Richmond
National Grid Reference: 518890, 175430
Slice: A
Site Area (Ha): 1.58
Search Buffer (m): 100

Site Details

Homebase Ltd, 84, Manor Road, RICHMOND, TW9 1YB

Landmark
INFORMATION GROUP

Tel: 0844 844 9952
Fax: 0844 844 9951
Web: www.envirocheck.co.uk

176000

176000

175800

175800

175600

175600

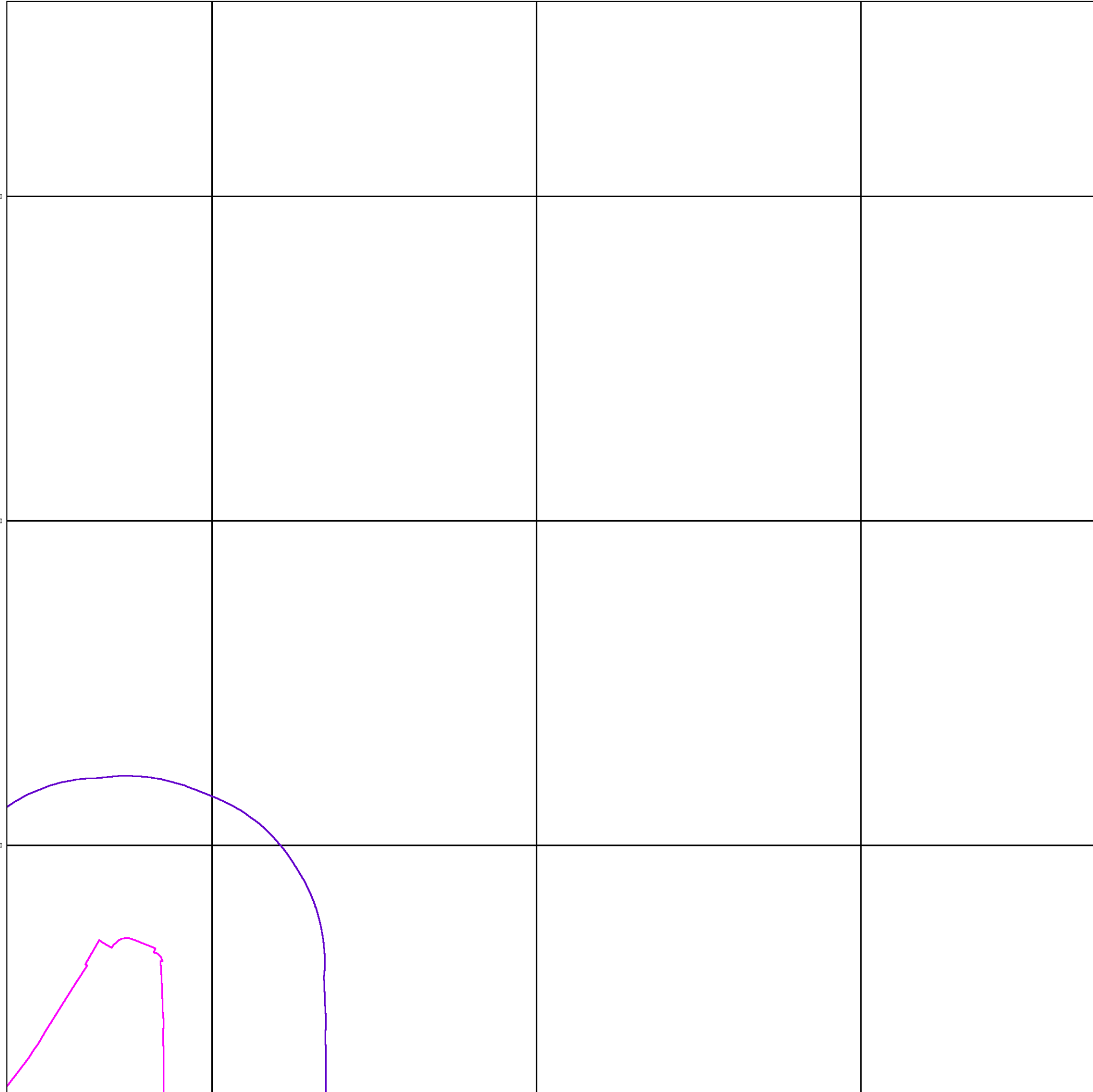

FAIRHURST

London

Published 1896

Source map scale - 1:2,500

The historical maps shown were reproduced from maps predominantly held at the scale adopted for England, Wales and Scotland in the 1840's. In 1854 the 1:2,500 scale was adopted for mapping urban areas and by 1896 it covered the whole of what were considered to be the cultivated parts of Great Britain. The published date given below is often some years later than the surveyed date. Before 1938, all OS maps were based on the Cassini Projection, with independent surveys of a single county or group of counties, giving rise to significant inaccuracies in outlying areas.

Map Name(s) and Date(s)

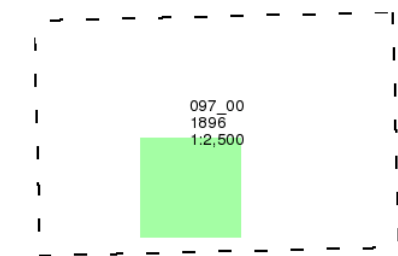

Historical Map - Segment A11

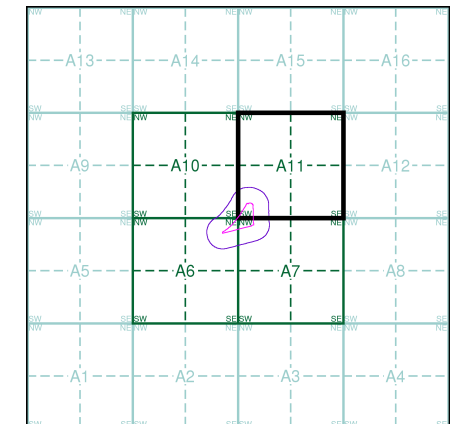

Order Details

Order Number: 142584674_1_1
 Customer Ref: Homebase, Richmond
 National Grid Reference: 518890, 175430
 Slice: A
 Site Area (Ha): 1.58
 Search Buffer (m): 100

Site Details

Homebase Ltd, 84, Manor Road, RICHMOND, TW9 1YB

Landmark
 INFORMATION GROUP

Tel: 0844 844 9952
 Fax: 0844 844 9951
 Web: www.envirocheck.co.uk

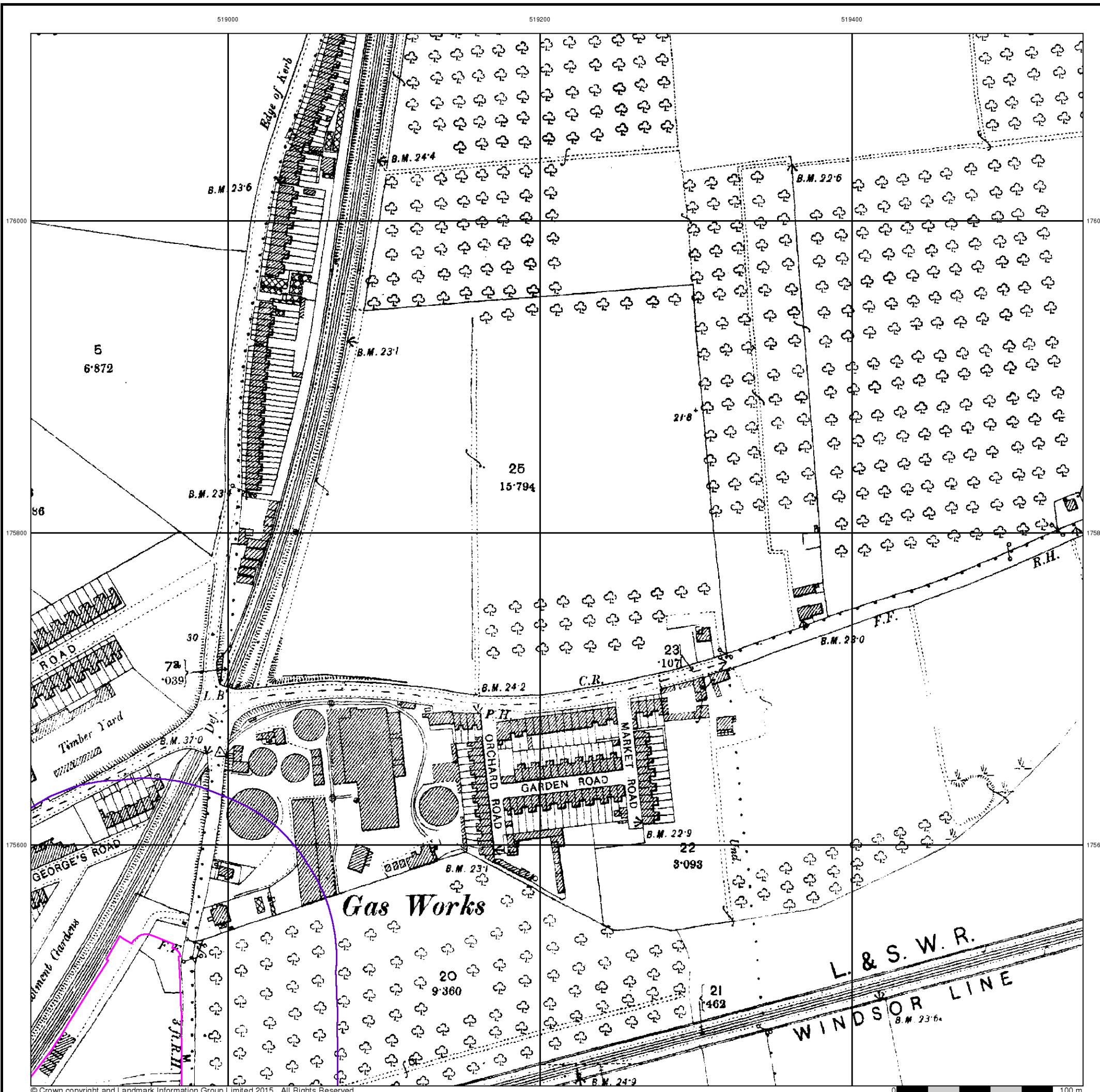

519000

519200

519400

FAIRHURST

Surrey

Published 1898

Source map scale - 1:2,500

The historical maps shown were reproduced from maps predominantly held at the scale adopted for England, Wales and Scotland in the 1840's. In 1854 the 1:2,500 scale was adopted for mapping urban areas and by 1896 it covered the whole of what were considered to be the cultivated parts of Great Britain. The published date given below is often some years later than the surveyed date. Before 1938, all OS maps were based on the Cassini Projection, with independent surveys of a single county or group of counties, giving rise to significant inaccuracies in outlying areas.

Map Name(s) and Date(s)

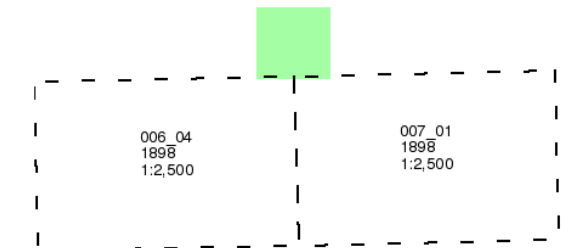

Historical Map - Segment A11

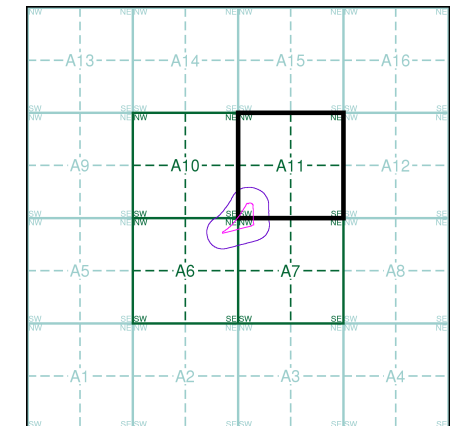

Order Details

Order Number: 142584674_1_1
 Customer Ref: Homebase, Richmond
 National Grid Reference: 518890, 175430
 Slice: A
 Site Area (Ha): 1.58
 Search Buffer (m): 100

Site Details

Homebase Ltd, 84, Manor Road, RICHMOND, TW9 1YB

Landmark
 INFORMATION GROUP

Tel: 0844 844 9952
 Fax: 0844 844 9951
 Web: www.envirocheck.co.uk

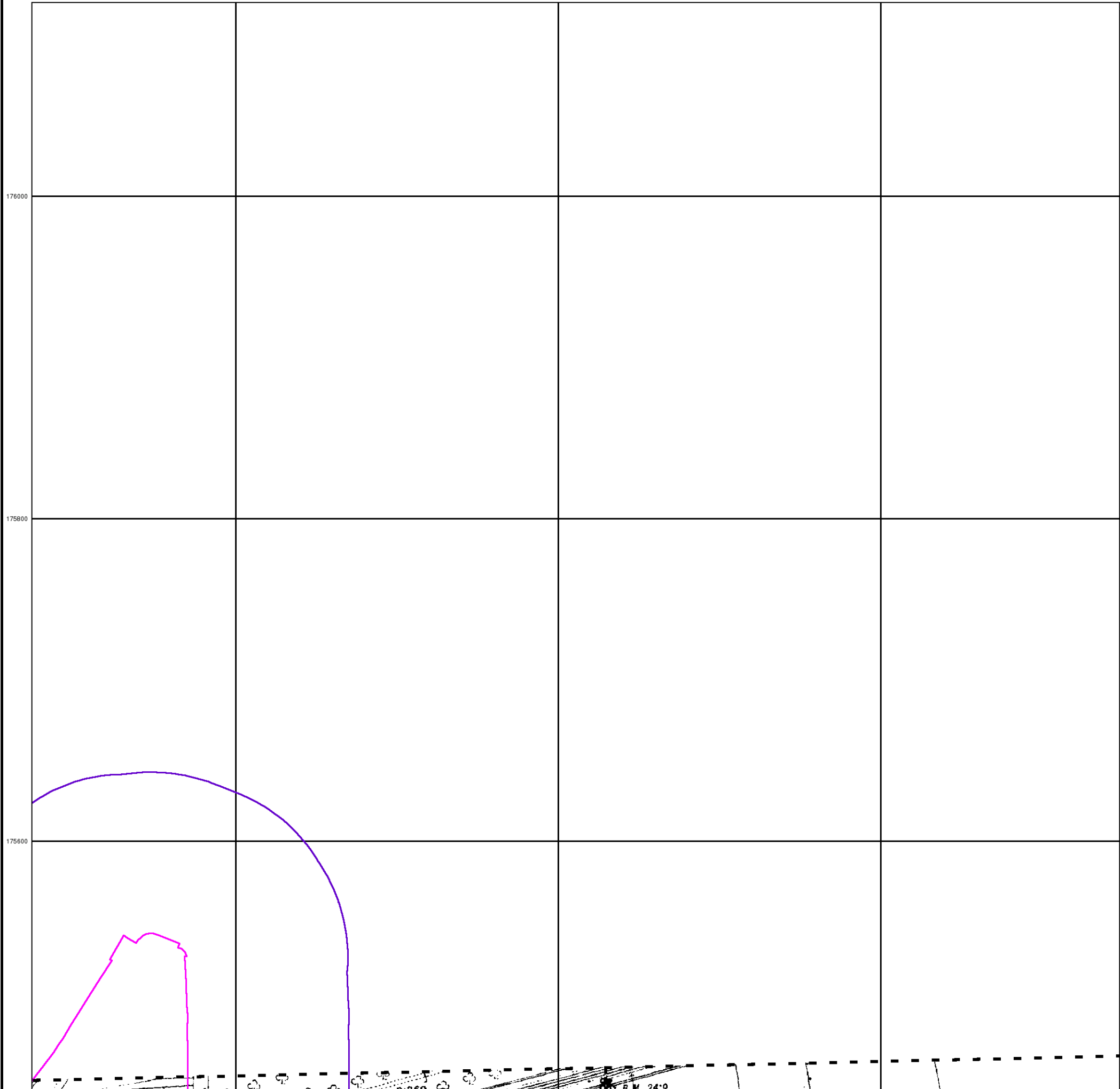

FAIRHURST

Surrey

Published 1913

Source map scale - 1:2,500

The historical maps shown were reproduced from maps predominantly held at the scale adopted for England, Wales and Scotland in the 1840's. In 1854 the 1:2,500 scale was adopted for mapping urban areas and by 1896 it covered the whole of what were considered to be the cultivated parts of Great Britain. The published date given below is often some years later than the surveyed date. Before 1938, all OS maps were based on the Cassini Projection, with independent surveys of a single county or group of counties, giving rise to significant inaccuracies in outlying areas.

Map Name(s) and Date(s)

001_16 1913 1:2,500	002_13 1913 1:2,500
006_04 1913 1:2,500	007_01 1913 1:2,500

Historical Map - Segment A11

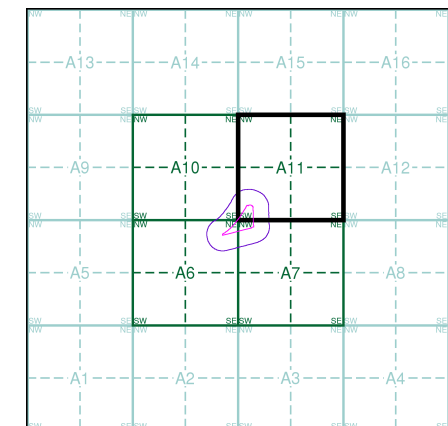

Order Details

Order Number: 142584674_1_1
 Customer Ref: Homebase, Richmond
 National Grid Reference: 518890, 175430
 Slice: A
 Site Area (Ha): 1.58
 Search Buffer (m): 100

Site Details

Homebase Ltd, 84, Manor Road, RICHMOND, TW9 1YB

Landmark
 INFORMATION GROUP

Tel: 0844 844 9952
 Fax: 0844 844 9951
 Web: www.envirocheck.co.uk

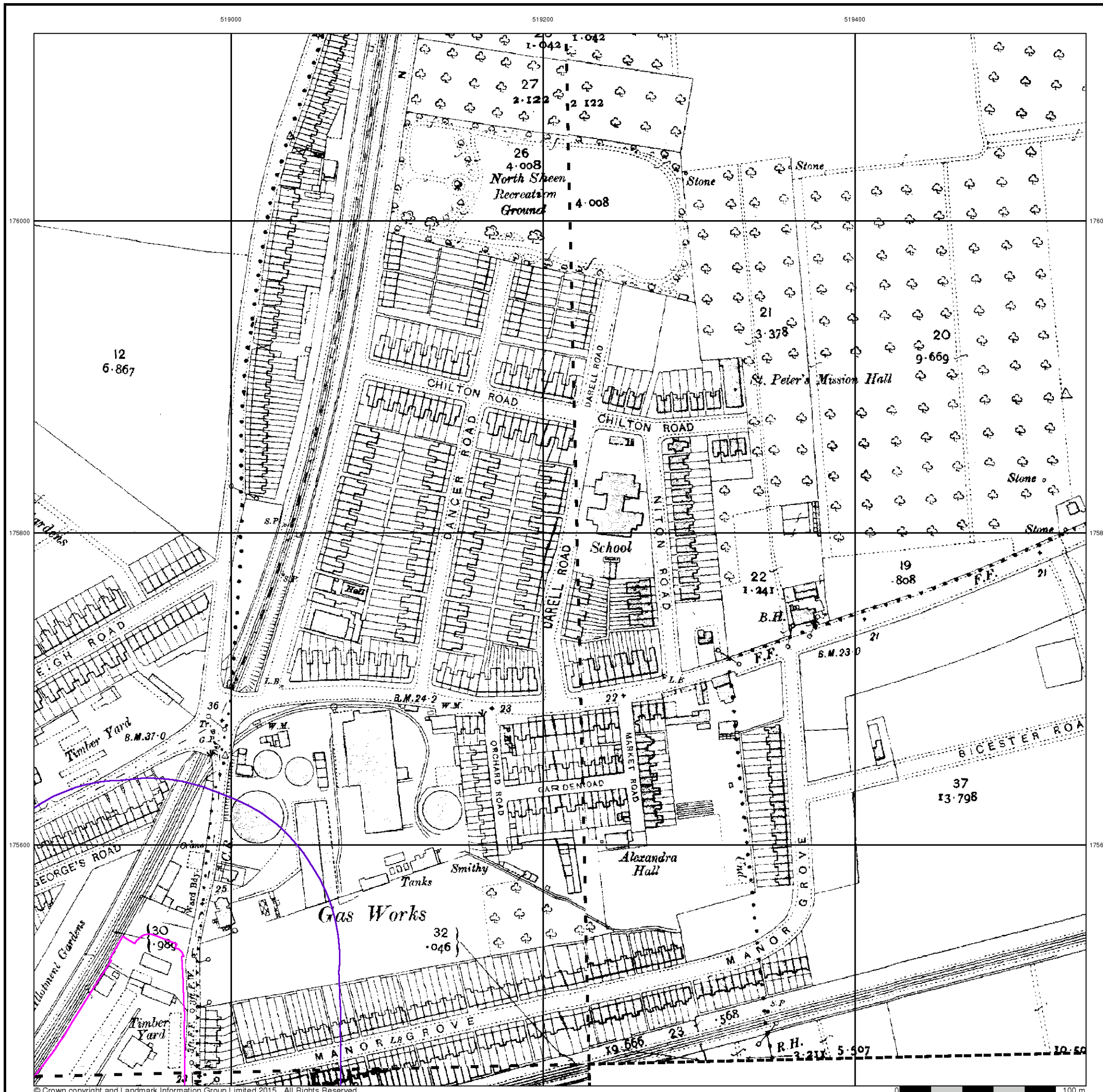

FAIRHURST

Middlesex

Published 1915

Source map scale - 1:2,500

The historical maps shown were reproduced from maps predominantly held at the scale adopted for England, Wales and Scotland in the 1840's. In 1854 the 1:2,500 scale was adopted for mapping urban areas and by 1896 it covered the whole of what were considered to be the cultivated parts of Great Britain. The published date given below is often some years later than the surveyed date. Before 1938, all OS maps were based on the Cassini Projection, with independent surveys of a single county or group of counties, giving rise to significant inaccuracies in outlying areas.

Map Name(s) and Date(s)

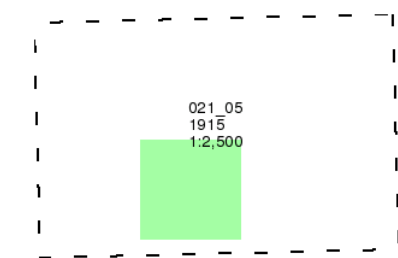

Historical Map - Segment A11

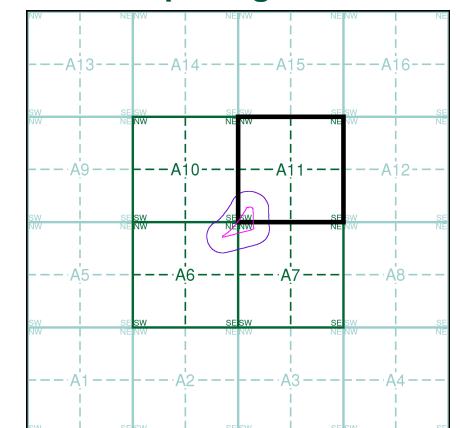

Order Details

Order Number: 142584674_1_1
Customer Ref: Homebase, Richmond
National Grid Reference: 518890, 175430
Slice: A
Site Area (Ha): 1.58
Search Buffer (m): 100

Site Details

Homebase Ltd, 84, Manor Road, RICHMOND, TW9 1YB

Landmark
INFORMATION GROUP

Tel: 0844 844 9952
Fax: 0844 844 9951
Web: www.envirocheck.co.uk

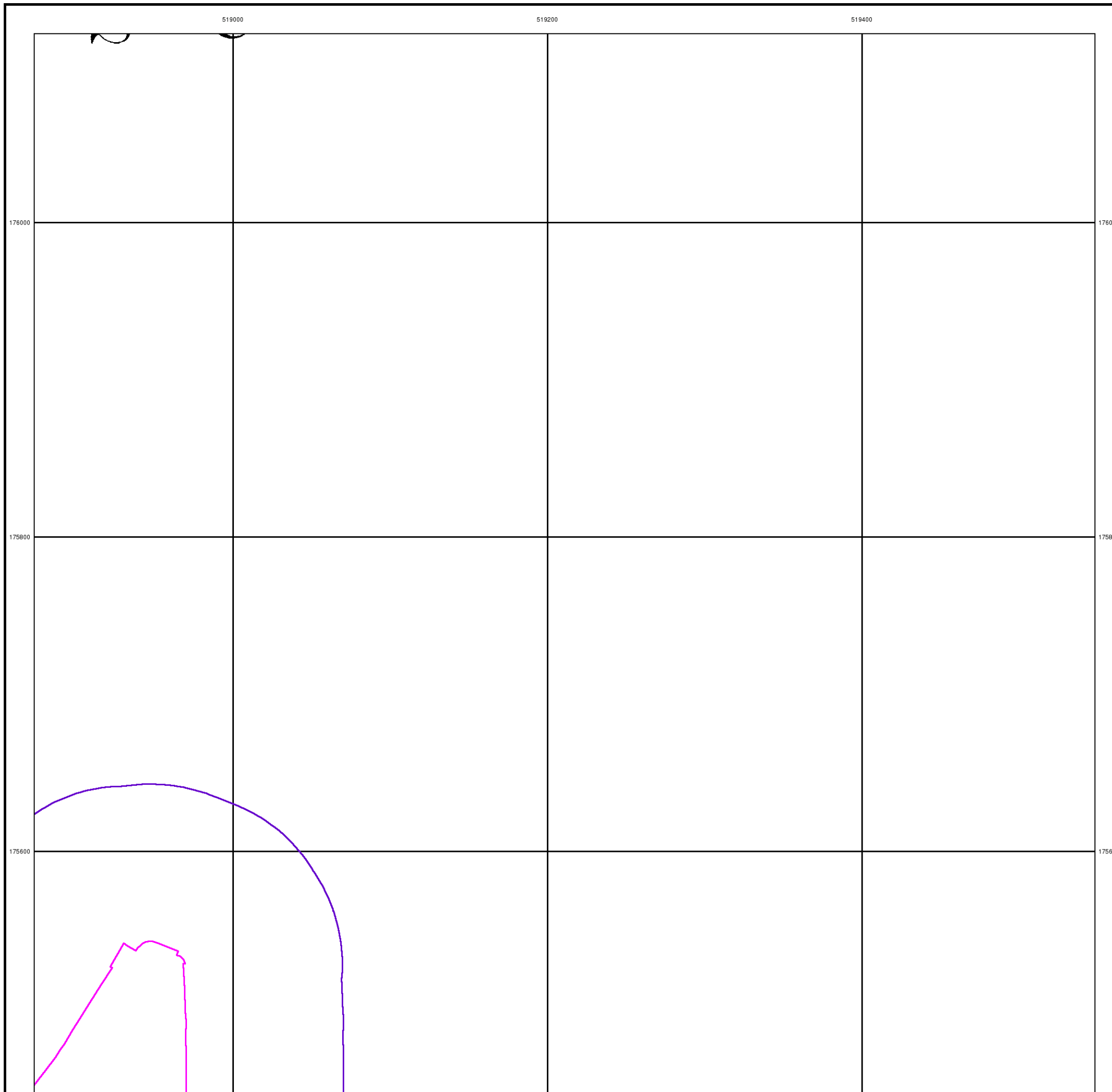

FAIRHURST

Surrey

Published 1934 - 1936

Source map scale - 1:2,500

The historical maps shown were reproduced from maps predominantly held at the scale adopted for England, Wales and Scotland in the 1840's. In 1854 the 1:2,500 scale was adopted for mapping urban areas and by 1896 it covered the whole of what were considered to be the cultivated parts of Great Britain. The published date given below is often some years later than the surveyed date. Before 1938, all OS maps were based on the Cassini Projection, with independent surveys of a single county or group of counties, giving rise to significant inaccuracies in outlying areas.

Map Name(s) and Date(s)

001_16 1934 1:2,500	002_13 1935 1:2,500
006_04 1936 1:2,500	007_01 1935 1:2,500

Historical Map - Segment A11

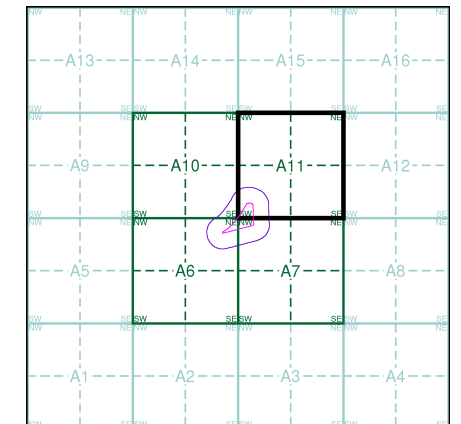

Order Details

Order Number: 142584674_1_1
 Customer Ref: Homebase, Richmond
 National Grid Reference: 518890, 175430
 Slice: A
 Site Area (Ha): 1.58
 Search Buffer (m): 100

Site Details

Homebase Ltd, 84, Manor Road, RICHMOND, TW9 1YB

Landmark
 INFORMATION GROUP

Tel: 0844 844 9952
 Fax: 0844 844 9951
 Web: www.envirocheck.co.uk

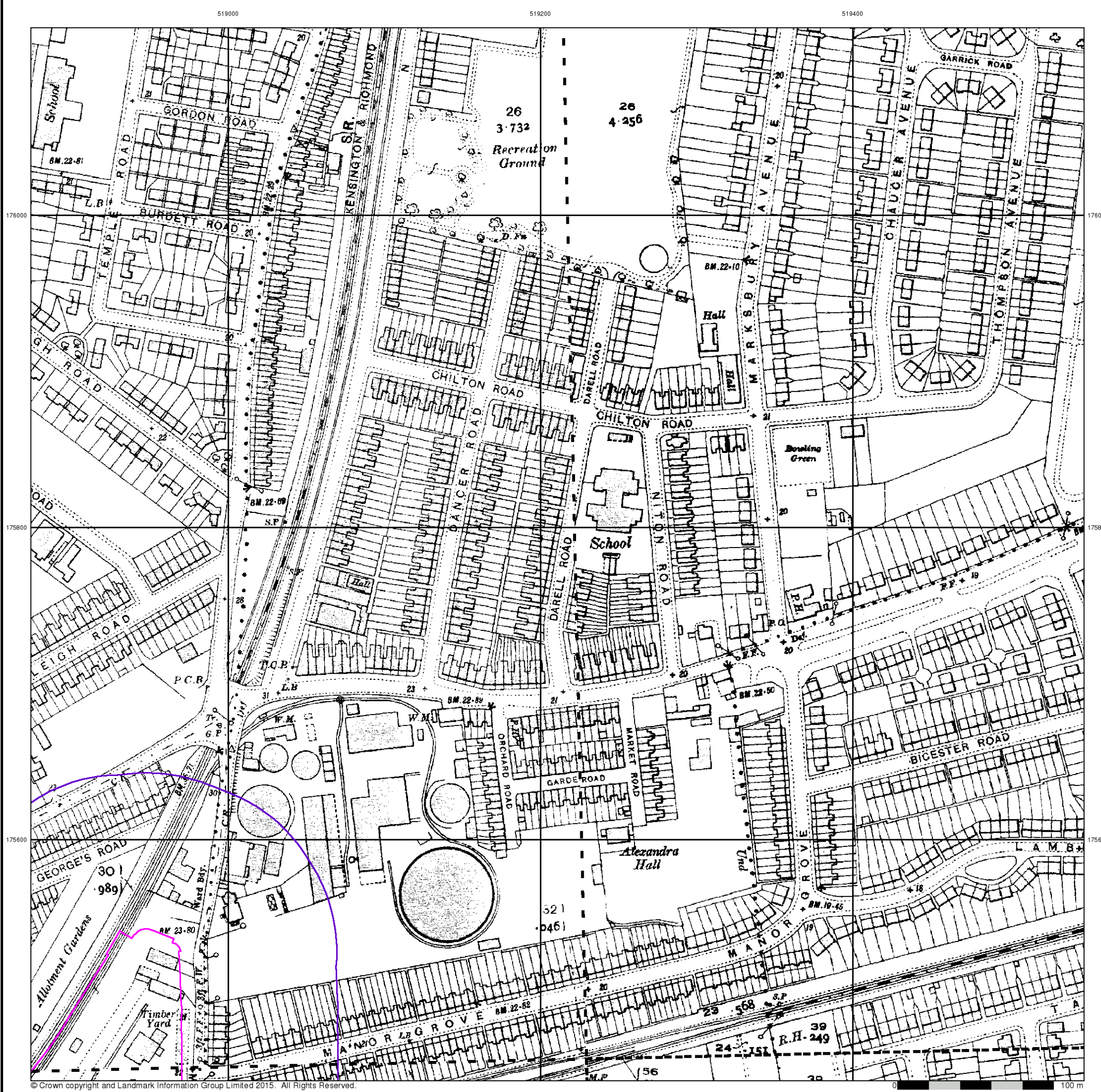

519000

519200

519400

FAIRHURST

Middlesex

Published 1935

Source map scale - 1:2,500

The historical maps shown were reproduced from maps predominantly held at the scale adopted for England, Wales and Scotland in the 1840's. In 1854 the 1:2,500 scale was adopted for mapping urban areas and by 1896 it covered the whole of what were considered to be the cultivated parts of Great Britain. The published date given below is often some years later than the surveyed date. Before 1938, all OS maps were based on the Cassini Projection, with independent surveys of a single county or group of counties, giving rise to significant inaccuracies in outlying areas.

Map Name(s) and Date(s)

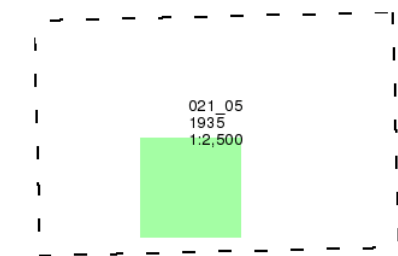

Historical Map - Segment A11

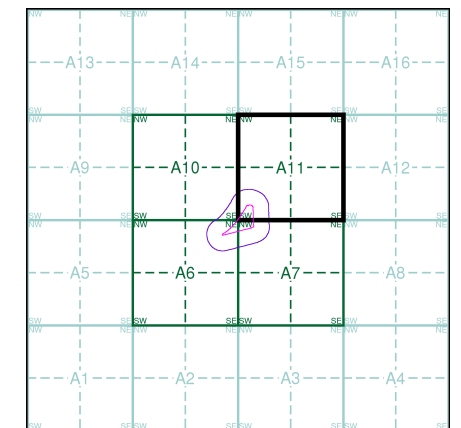

Order Details

Order Number: 142584674_1_1
Customer Ref: Homebase, Richmond
National Grid Reference: 518890, 175430
Slice: A
Site Area (Ha): 1.58
Search Buffer (m): 100

Site Details

Homebase Ltd, 84, Manor Road, RICHMOND, TW9 1YB

Landmark
INFORMATION GROUP

Tel: 0844 844 9952
Fax: 0844 844 9951
Web: www.envirocheck.co.uk

176000

176000

175800

175800

175600

175600

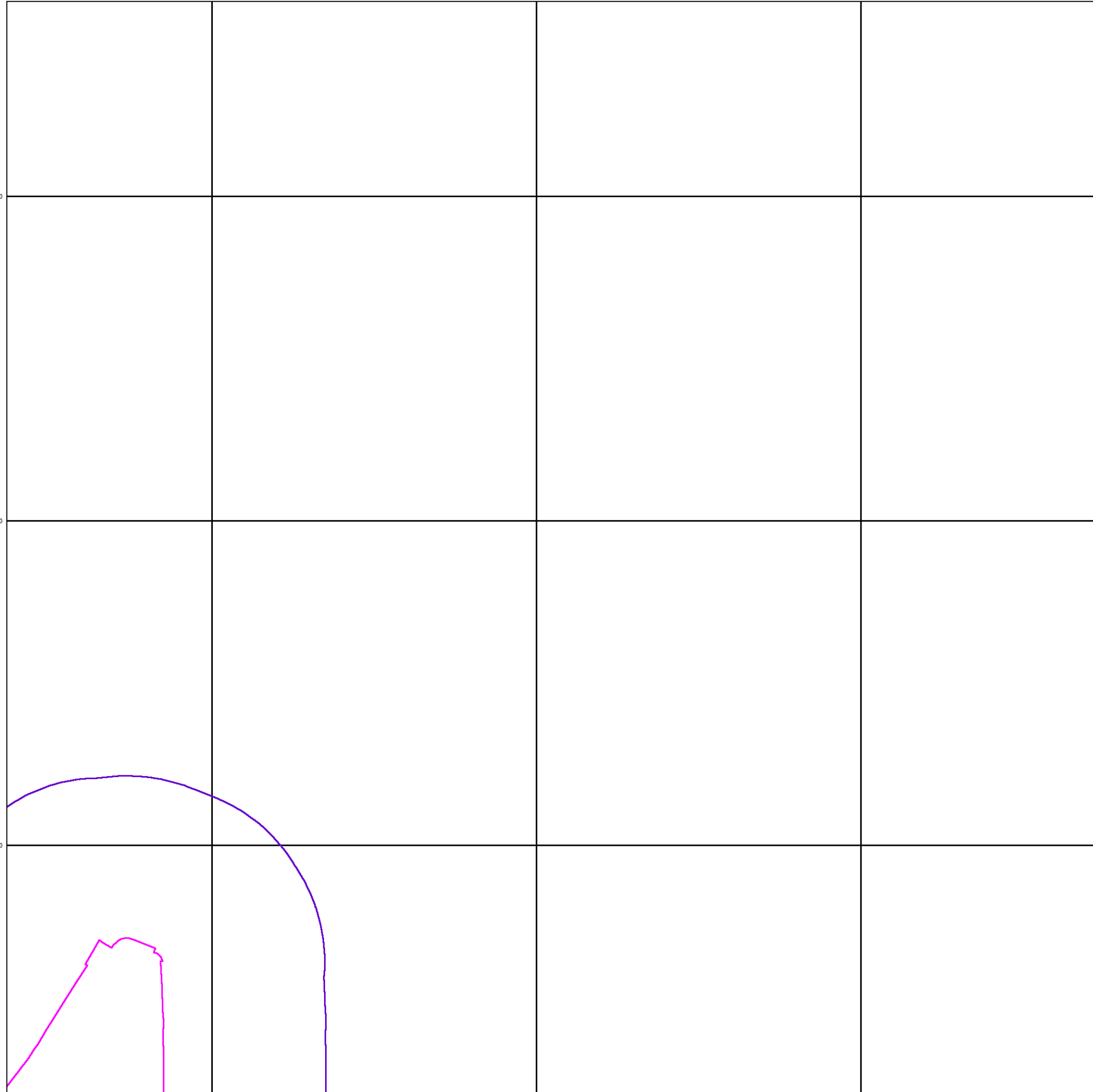

519000

519200

519400

FAIRHURST

Historical Aerial Photography

Published 1946 - 1947

Source map scale - 1:1,250

The Historical Aerial Photos were produced by the Ordnance Survey at a scale of 1:1,250 and 1:10,560 from Air Force photography. They were produced between 1944 and 1951 as an interim measure, pending preparation of conventional mapping, due to post war resource shortages. New security measures in the 1950's meant that every photograph was re-checked for potentially unsafe information with security sites replaced by fake fields or clouds. The original editions were withdrawn and only later made available after a period of fifty years although due to the accuracy of the editing, without viewing both revisions it is not easy to spot the edits. Where available Landmark have included both revisions.

© THE BRITISH LIBRARY BOARD. ALL RIGHTS RESERVED. Licence No:8048

Map Name(s) and Date(s)

TQ1876SE	TQ1976SW	TQ1976SE
1946	1946	1946
1:1,250	1:1,250	1:1,250
TQ1875NE	TQ1975NW	TQ1975NE
1946	1946	1946
1:1,250	1:1,250	1:1,250
TQ1875SE	TQ1975SW	
1947	1947	
1:1,250	1:1,250	

Historical Aerial Photography - Segment A11

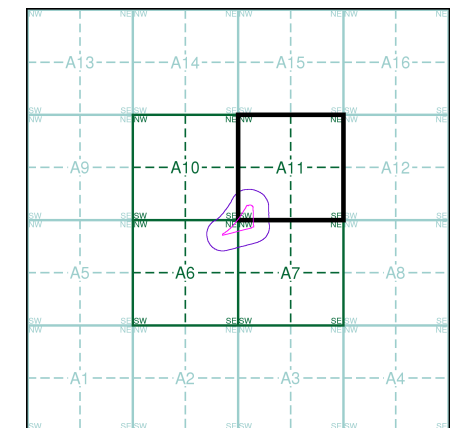

LIBRARY
HS111RB

Order Details

Order Number: 142584674_1_1
 Customer Ref: Homebase, Richmond
 National Grid Reference: 518890, 175430
 Slice: A
 Site Area (Ha): 1.58
 Search Buffer (m): 100

Site Details

Homebase Ltd, 84, Manor Road, RICHMOND, TW9 1YB

Landmark®
INFORMATION GROUP

Tel: 0844 844 9952
Fax: 0844 844 9951
Web: www.envirocheck.co.uk



© THE BRITISH LIBRARY BOARD. ALL RIGHTS RESERVED. Licence No:8048

FAIRHURST

Ordnance Survey Plan

Published 1960 - 1961

Source map scale - 1:2,500

The historical maps shown were reproduced from maps predominantly held at the scale adopted for England, Wales and Scotland in the 1840's. In 1854 the 1:2,500 scale was adopted for mapping urban areas and by 1896 it covered the whole of what were considered to be the cultivated parts of Great Britain. The published date given below is often some years later than the surveyed date. Before 1938, all OS maps were based on the Cassini Projection, with independent surveys of a single county or group of counties, giving rise to significant inaccuracies in outlying areas.

Map Name(s) and Date(s)

TQ1876 1961 12,500	TQ1976 1961 12,500
TQ1875 1960 12,500	TQ1975 1960 12,500

Historical Map - Segment A11

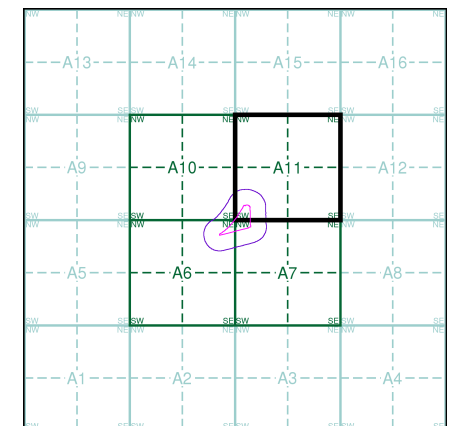

Order Details

Order Number: 142584674_1_1
 Customer Ref: Homebase, Richmond
 National Grid Reference: 518890, 175430
 Slice: A
 Site Area (Ha): 1.58
 Search Buffer (m): 100

Site Details

Homebase Ltd, 84, Manor Road, RICHMOND, TW9 1YB



Tel: 0844 844 9952
 Fax: 0844 844 9951
 Web: www.envirocheck.co.uk



FAIRHURST

Ordnance Survey Plan

Published 1960

Source map scale - 1:1,250

The historical maps shown were reproduced from maps predominantly held at the scale adopted for England, Wales and Scotland in the 1840's. In 1854 the 1:2,500 scale was adopted for mapping urban areas and by 1896 it covered the whole of what were considered to be the cultivated parts of Great Britain. The published date given below is often some years later than the surveyed date. Before 1938, all OS maps were based on the Cassini Projection, with independent surveys of a single county or group of counties, giving rise to significant inaccuracies in outlying areas.

Map Name(s) and Date(s)

TQ1876SE	TQ1976SW	TQ1976SE
1960	1960	1960
1:1,250	1:1,250	1:1,250
TQ1875NE	TQ1975NW	TQ1975NE
1960	1960	1960
1:1,250	1:1,250	1:1,250
TQ1875SE	TQ1975SW	TQ1975SE
1960	1960	1960
1:1,250	1:1,250	1:1,250

Historical Map - Segment A11

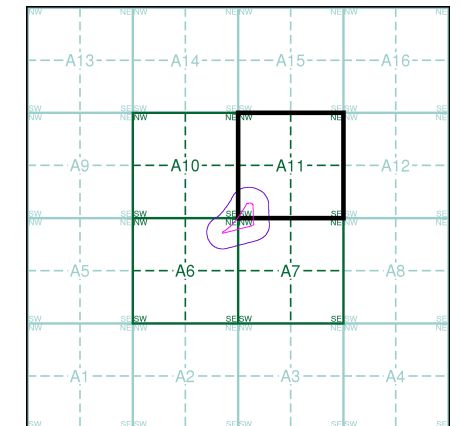

Order Details

Order Number: 142584674_1_1
 Customer Ref: Homebase, Richmond
 National Grid Reference: 518890, 175430
 Slice: A
 Site Area (Ha): 1.58
 Search Buffer (m): 100

Site Details

Homebase Ltd, 84, Manor Road, RICHMOND, TW9 1YB

Landmark
 INFORMATION GROUP

Tel: 0844 844 9952
 Fax: 0844 844 9951
 Web: www.envirocheck.co.uk

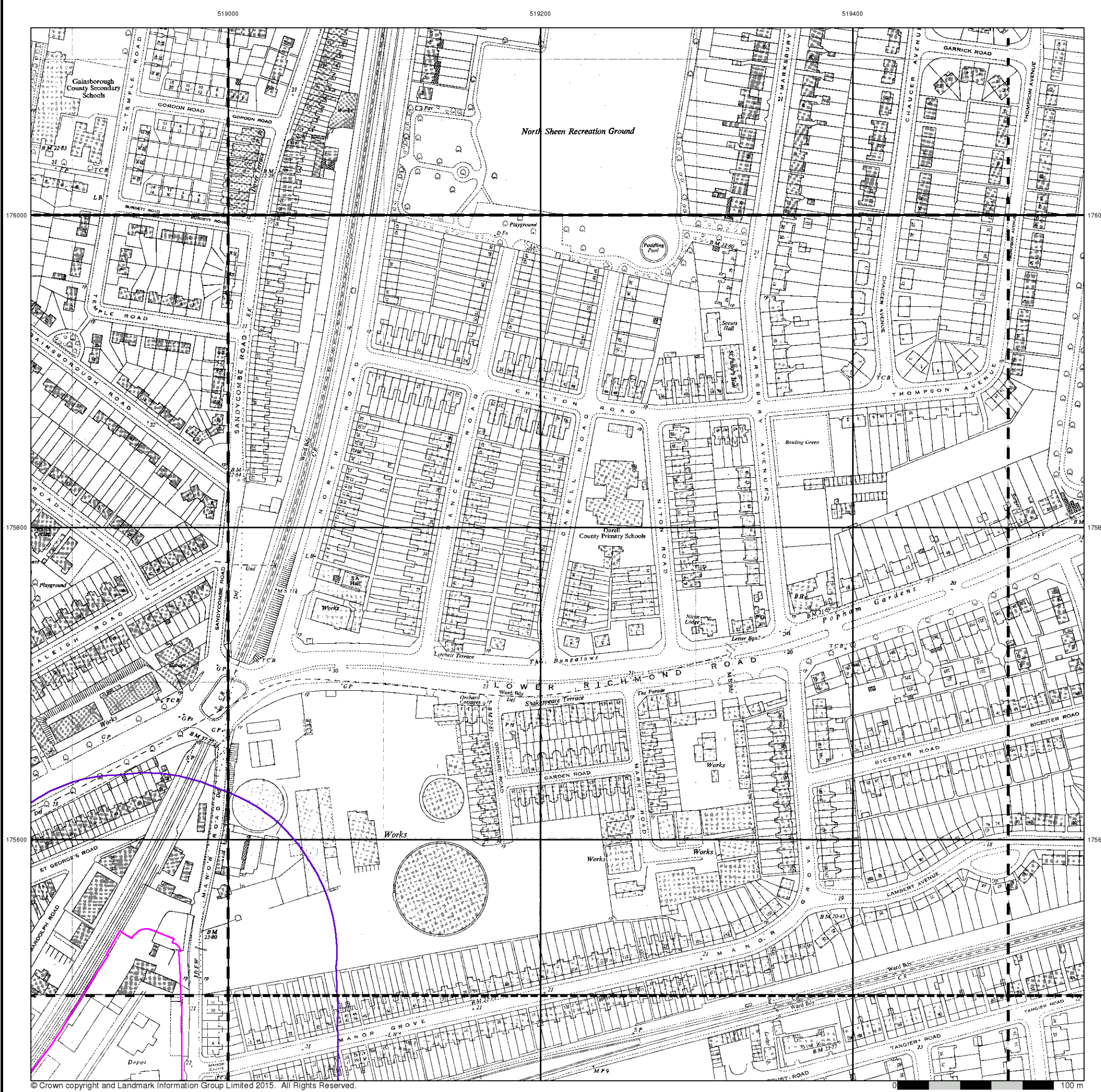

FAIRHURST

Additional SIMs

Published 1960 - 1961

Source map scale - 1:2,500

The SIM cards (Ordnance Survey's 'Survey of Information on Microfilm') are further, minor editions of mapping which were produced and published in between the main editions as an area was updated. They date from 1947 to 1994, and contain detailed information on buildings, roads and land-use. These maps were produced at both 1:2,500 and 1:1,250 scales.

Map Name(s) and Date(s)

TQ1876 1961 1:2,500	TQ1976 1961 1:2,500
TQ1875 1960 1:2,500	TQ1975 1960 1:2,500

Historical Map - Segment A11

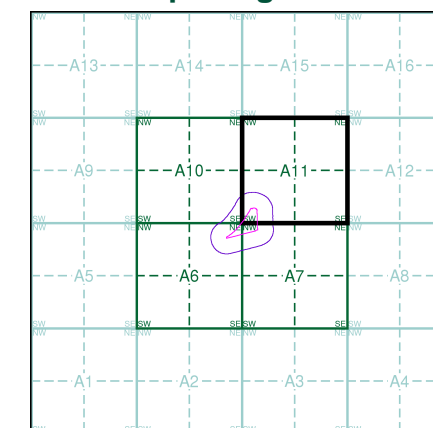

Order Details

Order Number: 142584674_1_1
Customer Ref: Homebase, Richmond
National Grid Reference: 518890, 175430
Slice: A
Site Area (Ha): 1.58
Search Buffer (m): 100

Site Details

Homebase Ltd, 84, Manor Road, RICHMOND, TW9 1YB

Landmark
INFORMATION GROUP

Tel: 0844 844 9952
Fax: 0844 844 9951
Web: www.envirocheck.co.uk



FAIRHURST

Additional SIMs

Published 1960 - 1980

Source map scale - 1:1,250

The SIM cards (Ordnance Survey's 'Survey of Information on Microfilm') are further, minor editions of mapping which were produced and published in between the main editions as an area was updated. They date from 1947 to 1994, and contain detailed information on buildings, roads and land-use. These maps were produced at both 1:2,500 and 1:1,250 scales.

Map Name(s) and Date(s)

TQ1876SE	TQ1976SW	
1968	1960	
1:1,250	1:1,250	
TQ1875NE	TQ1975NE	
1974	1978	
1:1,250	1:1,250	
TQ1875SE	TQ1975SW	TQ1975SE
1960	1980	1960
1:1,250	1:1,250	1:1,250

Historical Map - Segment A11

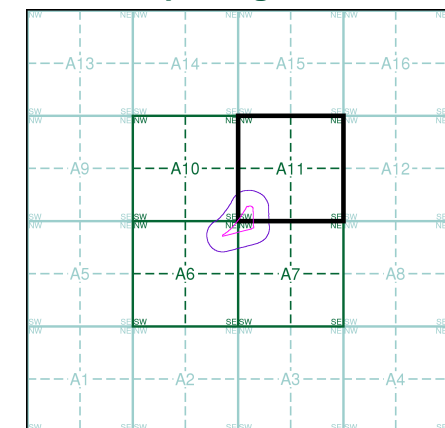

Order Details

Order Number: 142584674_1_1
Customer Ref: Homebase, Richmond
National Grid Reference: 518890, 175430
Slice: A
Site Area (Ha): 1.58
Search Buffer (m): 100

Site Details

Homebase Ltd, 84, Manor Road, RICHMOND, TW9 1YB

Landmark
INFORMATION GROUP

Tel: 0844 844 9952
Fax: 0844 844 9951
Web: www.envirocheck.co.uk

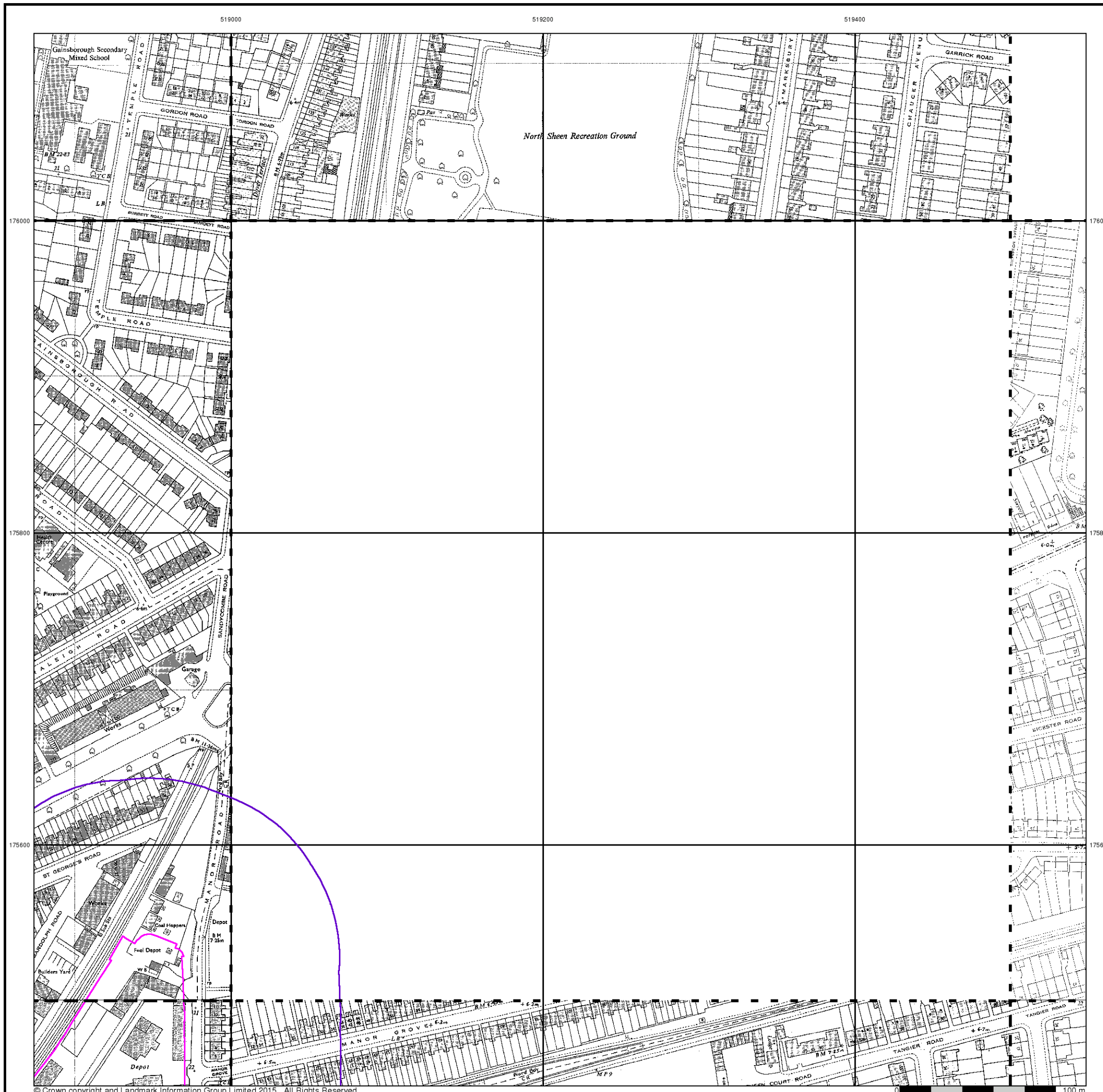

519000

519200

519400

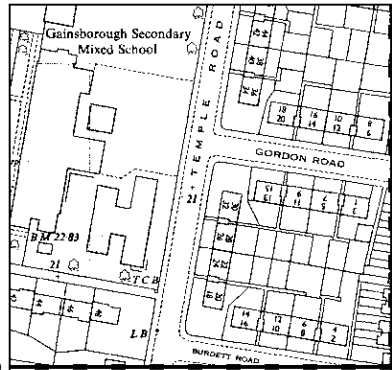

176000

176000

175800

175800

175600

175600

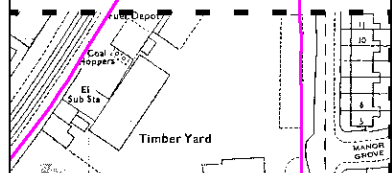

© Crown copyright and Landmark Information Group Limited 2015. All Rights Reserved.

0 100 m

FAIRHURST

Ordnance Survey Plan

Published 1968 - 1974

Source map scale - 1:1,250

The historical maps shown were reproduced from maps predominantly held at the scale adopted for England, Wales and Scotland in the 1840's. In 1854 the 1:2,500 scale was adopted for mapping urban areas and by 1896 it covered the whole of what were considered to be the cultivated parts of Great Britain. The published date given below is often some years later than the surveyed date. Before 1938, all OS maps were based on the Cassini Projection, with independent surveys of a single county or group of counties, giving rise to significant inaccuracies in outlying areas.

Map Name(s) and Date(s)

TQ1876SE
1968
1:1,250

TQ1875SE
1974
1:1,250

Historical Map - Segment A11

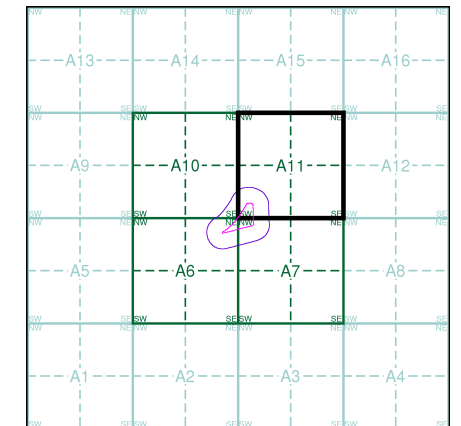

Order Details

Order Number: 142584674_1_1
 Customer Ref: Homebase, Richmond
 National Grid Reference: 518890, 175430
 Slice: A
 Site Area (Ha): 1.58
 Search Buffer (m): 100

Site Details

Homebase Ltd, 84, Manor Road, RICHMOND, TW9 1YB

Landmark
 INFORMATION GROUP

Tel: 0844 844 9952
 Fax: 0844 844 9951
 Web: www.envirocheck.co.uk

519000

519200

519400

FAIRHURST

Additional SIMs

Published 1973 - 1988

Source map scale - 1:1,250

The SIM cards (Ordnance Survey's 'Survey of Information on Microfilm') are further, minor editions of mapping which were produced and published in between the main editions as an area was updated. They date from 1947 to 1994, and contain detailed information on buildings, roads and land-use. These maps were produced at both 1:2,500 and 1:1,250 scales.

Map Name(s) and Date(s)

TQ1878SE 1980 1:1,250	TQ1975NE 1988 1:1,250
TQ1875SE 1974 1:1,250	TQ1975SE 1973 1:1,250

Historical Map - Segment A11

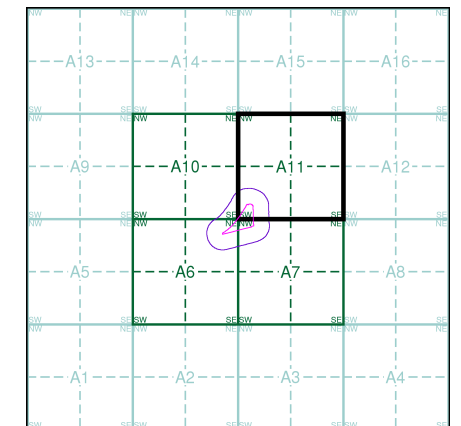

Order Details

Order Number: 142584674_1_1
 Customer Ref: Homebase, Richmond
 National Grid Reference: 518890, 175430
 Slice: A
 Site Area (Ha): 1.58
 Search Buffer (m): 100

Site Details

Homebase Ltd, 84, Manor Road, RICHMOND, TW9 1YB

Landmark
 INFORMATION GROUP

Tel: 0844 844 9952
 Fax: 0844 844 9951
 Web: www.envirocheck.co.uk



FAIRHURST

Supply of Unpublished Survey Information

Published 1974

Source map scale - 1:1,250

SUSI maps (Supply of Unpublished Survey Information) were produced between 1972 and 1977, mainly for internal use at Ordnance Survey. These were more of a 'work-in-progress' plan as they showed updates of individual areas on a map. These maps were unpublished, and they do not represent a single moment in time. They were produced at both 1:2,500 and 1:1,250 scales.

Map Name(s) and Date(s)

TQ1878SE 1974 1:1,250	TQ1978SE 1974 1:1,250
TQ1875SE 1974 1:1,250	TQ1975SW 1974 1:1,250

Historical Map - Segment A11

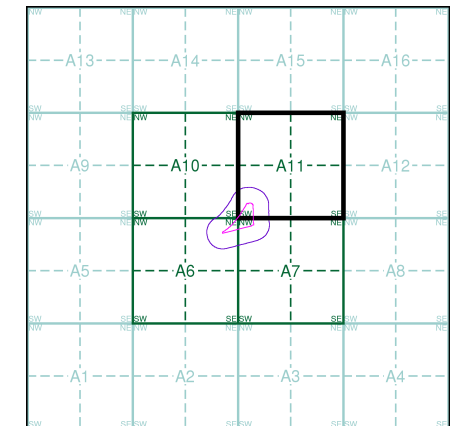

Order Details

Order Number: 142584674_1_1
Customer Ref: Homebase, Richmond
National Grid Reference: 518890, 175430
Slice: A
Site Area (Ha): 1.58
Search Buffer (m): 100

Site Details

Homebase Ltd, 84, Manor Road, RICHMOND, TW9 1YB

Landmark
INFORMATION GROUP

Tel: 0844 844 9952
Fax: 0844 844 9951
Web: www.envirocheck.co.uk

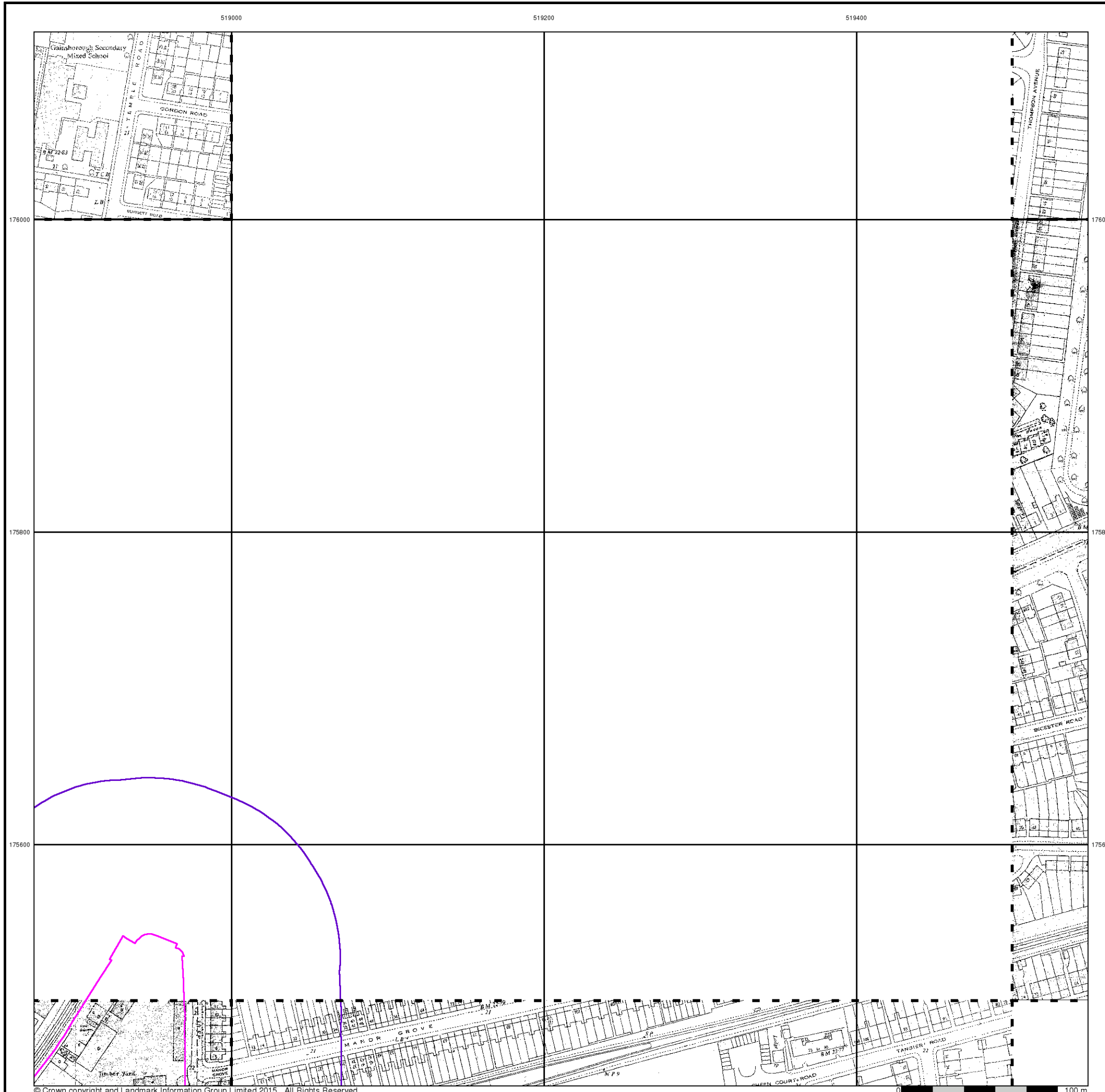

519000

519200

519400

176000

176000

175800

175800

175600

175600

FAIRHURST

Additional SIMs

Published 1983

Source map scale - 1:1,250

The SIM cards (Ordnance Survey's 'Survey of Information on Microfilm') are further, minor editions of mapping which were produced and published in between the main editions as an area was updated. They date from 1947 to 1994, and contain detailed information on buildings, roads and land-use. These maps were produced at both 1:2,500 and 1:1,250 scales.

Map Name(s) and Date(s)

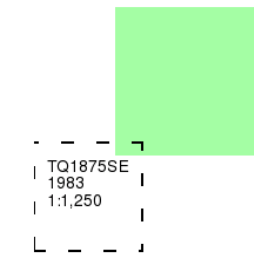

Historical Map - Segment A11

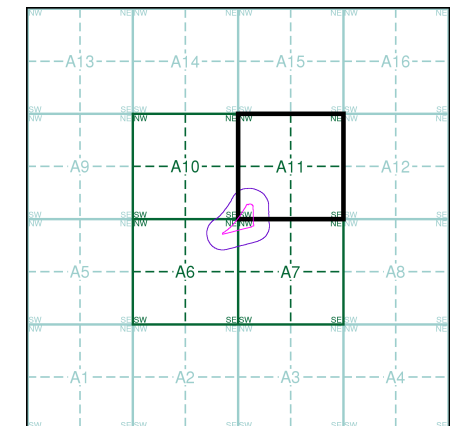

Order Details

Order Number: 142584674_1_1
Customer Ref: Homebase, Richmond
National Grid Reference: 518890, 175430
Slice: A
Site Area (Ha): 1.58
Search Buffer (m): 100

Site Details

Homebase Ltd, 84, Manor Road, RICHMOND, TW9 1YB

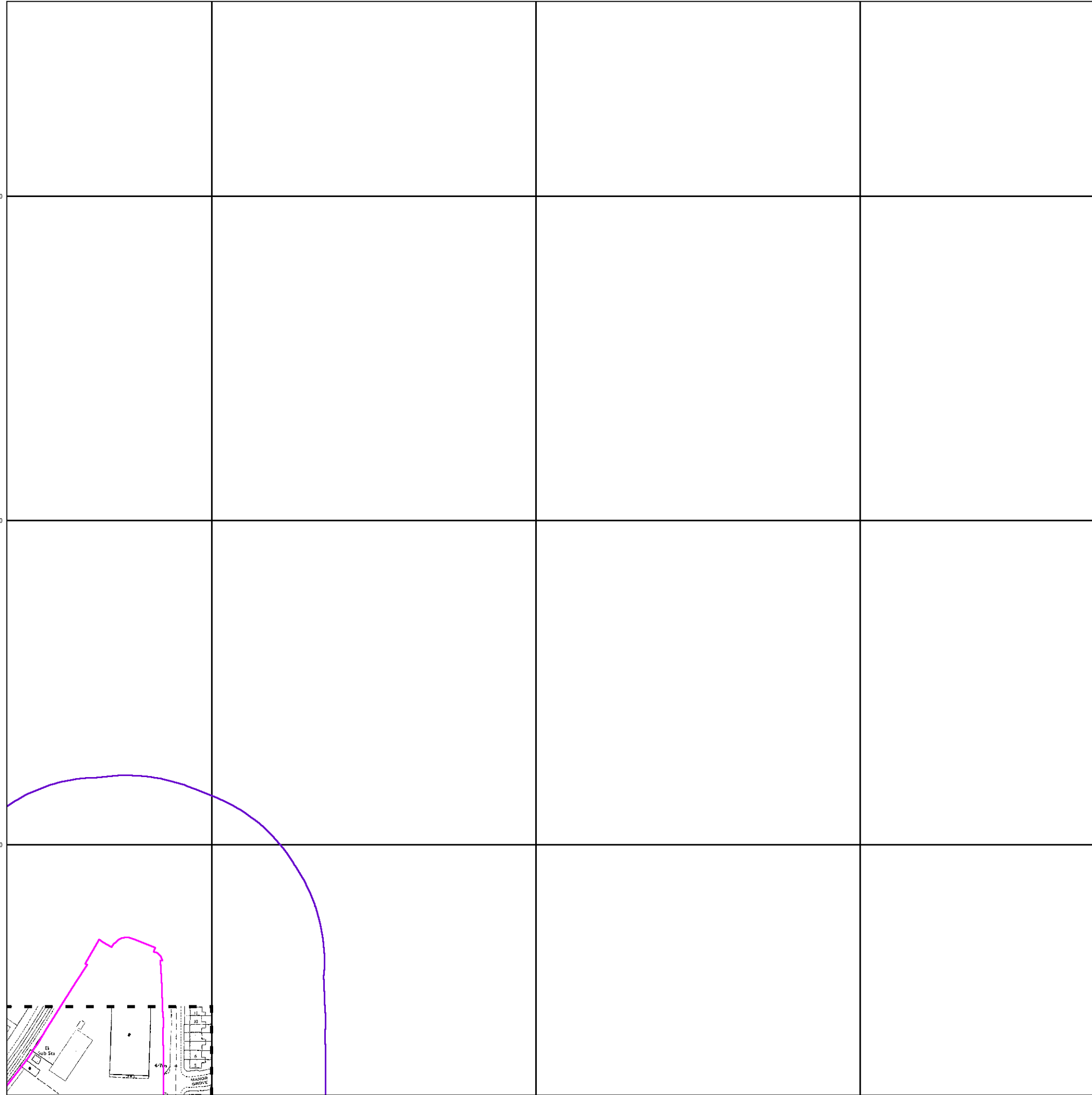

519000

519200

519400

176000

176000

175800

175800

175600

175600

FAIRHURST

Additional SIMs

Published 1989

Source map scale - 1:1,250

The SIM cards (Ordnance Survey's 'Survey of Information on Microfilm') are further, minor editions of mapping which were produced and published in between the main editions as an area was updated. They date from 1947 to 1994, and contain detailed information on buildings, roads and land-use. These maps were produced at both 1:2,500 and 1:1,250 scales.

Map Name(s) and Date(s)

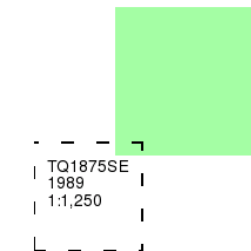

Historical Map - Segment A11

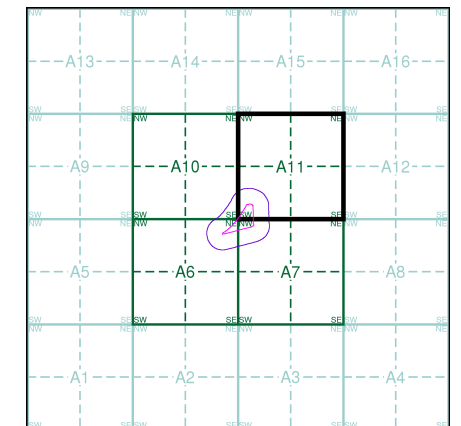

Order Details

Order Number: 142584674_1_1
Customer Ref: Homebase, Richmond
National Grid Reference: 518890, 175430
Slice: A
Site Area (Ha): 1.58
Search Buffer (m): 100

Site Details

Homebase Ltd, 84, Manor Road, RICHMOND, TW9 1YB

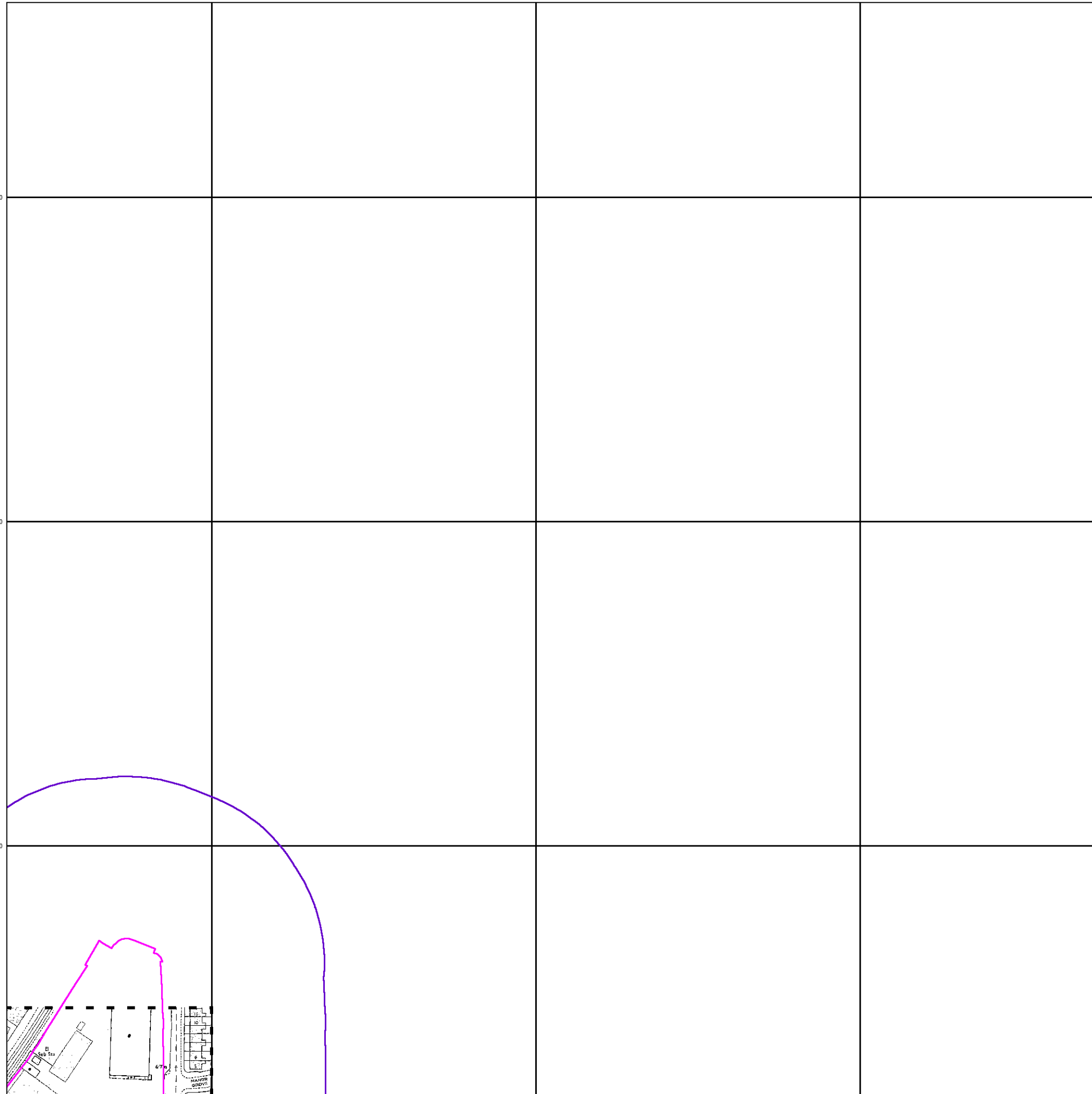

FAIRHURST

Large-Scale National Grid Data

Published 1991

Source map scale - 1:1,250

'Large Scale National Grid Data' superseded SIM cards (Ordnance Survey's 'Survey of Information on Microfilm') in 1992, and continued to be produced until 1999. These maps were the fore-runners of digital mapping and so provide detailed information on houses and roads, but tend to show less topographic features such as vegetation. These maps were produced at both 1:2,500 and 1:1,250 scales.

Map Name(s) and Date(s)

TQ1876SE	TQ1976SW	TQ1976SE
1991	1991	1991
1:1,250	1:1,250	1:1,250
TQ1875NE	TQ1975NW	TQ1975NE
1991	1991	1991
1:1,250	1:1,250	1:1,250
TQ1875SE	TQ1975SW	TQ1975SE
1991	1991	1991
1:1,250	1:1,250	1:1,250

Historical Map - Segment A11

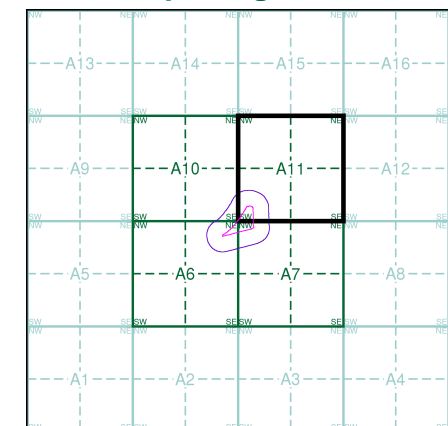

Order Details

Order Number: 142584674_1_1
 Customer Ref: Homebase, Richmond
 National Grid Reference: 518890, 175430
 Slice: A
 Site Area (Ha): 1.58
 Search Buffer (m): 100

Site Details

Homebase Ltd, 84, Manor Road, RICHMOND, TW9 1YB

Landmark
 INFORMATION GROUP

Tel: 0844 844 9952
 Fax: 0844 844 9951
 Web: www.envirocheck.co.uk



FAIRHURST

Large-Scale National Grid Data

Published 1992 - 1994

Source map scale - 1:1,250

'Large Scale National Grid Data' superseded SIM cards (Ordnance Survey's 'Survey of Information on Microfilm') in 1992, and continued to be produced until 1999. These maps were the fore-runners of digital mapping and so provide detailed information on houses and roads, but tend to show less topographic features such as vegetation. These maps were produced at both 1:2,500 and 1:1,250 scales.

Map Name(s) and Date(s)

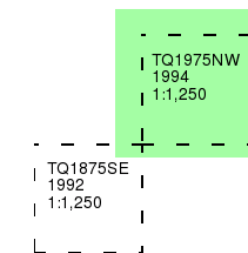

Historical Map - Segment A11

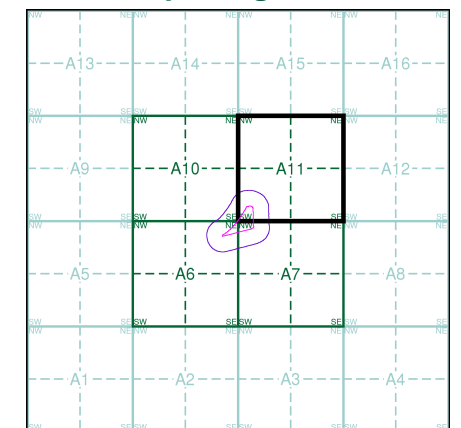

Order Details

Order Number: 142584674_1_1
Customer Ref: Homebase, Richmond
National Grid Reference: 518890, 175430
Slice: A
Site Area (Ha): 1.58
Search Buffer (m): 100

Site Details

Homebase Ltd, 84, Manor Road, RICHMOND, TW9 1YB

Landmark
INFORMATION GROUP

Tel: 0844 844 9952
Fax: 0844 844 9951
Web: www.envirocheck.co.uk

