

**APPENDIX B**  
**Envirocheck Report**

# Historical Mapping Legends

## Ordnance Survey County Series 1:10,560

	Gravel Pit		Sand Pit		Other Pits
	Quarry		Shingle		Orchard
	Osiers		Reeds		Marsh
	Mixed Wood		Deciduous		Brushwood
	Fir		Furze		Rough Pasture
	Arrow denotes flow of water		Trigonometrical Station		
	Site of Antiquities		Bench Mark		
	Pump, Guide Post, Signal Post		Well, Spring, Boundary Post		
	<b>-285</b> Surface Level				
	Sketched Contour		Instrumental Contour		
	Main Roads		Minor Roads		
	Sunken Road		Raised Road		
	Road over Railway		Railway over River		
	Railway over Road		Level Crossing		
	Road over River or Canal		Road over Stream		
	Road over Stream				
	County Boundary (Geographical)				
	County & Civil Parish Boundary				
	Administrative County & Civil Parish Boundary				
	County Borough Boundary (England)				
	County Burgh Boundary (Scotland)				
	Rural District Boundary				
	Civil Parish Boundary				

## Ordnance Survey Plan 1:10,000

	Chalk Pit, Clay Pit or Quarry		Gravel Pit
	Sand Pit		Disused Pit or Quarry
	Refuse or Slag Heap		Lake, Loch or Pond
	Dunes		Boulders
	Coniferous Trees		Non-Coniferous Trees
	Orchard		Scrub
	Coppice		
	Bracken		Heath
	Rough Grassland		
	Marsh		Reeds
	Saltings		
	Building		Glasshouse
	Sloping Masonry		Pylon
	Electricity Transmission Line		Pole
	Cutting		Embankment
	Standard Gauge Multiple Track		
	Standard Gauge Single Track		
	Siding, Tramway or Mineral Line		
	Narrow Gauge		
	Geographical County		
	Administrative County, County Borough or County of City		
	Municipal Borough, Urban or Rural District, Burgh or District Council		
	Borough, Burgh or County Constituency Shown only when not coincident with other boundaries		
	Civil Parish Shown alternately when coincidence of boundaries occurs		
	BP, BS Boundary Post or Stone		Pol Sta Police Station
	Ch Church		PO Post Office
	CH Club House		PC Public Convenience
	F E Sta Fire Engine Station		PH Public House
	FB Foot Bridge		SB Signal Box
	Fn Fountain		Spr Spring
	GP Guide Post		TCB Telephone Call Box
	MP Mile Post		TCP Telephone Call Post
	MS Mile Stone		W Well

## 1:10,000 Raster Mapping

	Gravel Pit		Refuse tip or slag heap
	Rock		Rock (scattered)
	Boulders		Boulders (scattered)
	Shingle		Mud
	Sand		Sand Pit
	Slopes		Top of cliff
	General detail		Underground detail
	Overhead detail		Narrow gauge railway
	Multi-track railway		Single track railway
	County boundary (England only)		Civil, parish or community boundary
	District, Unitary, Metropolitan, London Borough boundary		Constituency boundary
	Area of wooded vegetation		Non-coniferous trees
	Non-coniferous trees (scattered)		Coniferous trees
	Coniferous trees (scattered)		Positioned tree
	Orchard		Coppice or Osiers
	Rough Grassland		Heath
	Scrub		Marsh, Salt Marsh or Reeds
	Water feature		Flow arrows
	MHW(S) Mean high water (springs)		MLW(S) Mean low water (springs)
	Telephone line (where shown)		Electricity transmission line (with poles)
	Bench mark (where shown)		Triangulation station
	Point feature (e.g. Guide Post or Mile Stone)		Pylon, flare stack or lighting tower
	Site of (antiquity)		Glasshouse
	General Building		Important Building

# FAIRHURST

## Historical Mapping & Photography included:

Mapping Type	Scale	Date	Pg
Middlesex	1:10,560	1869 - 1873	3
Surrey	1:10,560	1871 - 1874	4
London	1:10,560	1896	5
Surrey	1:10,560	1898 - 1899	6
Middlesex	1:10,560	1920	7
Surrey	1:10,560	1920	8
London	1:10,560	1920	9
Surrey	1:10,560	1933	10
Surrey	1:10,560	1933	11
Middlesex	1:10,560	1935	12
Surrey	1:10,560	1938	13
Middlesex	1:10,560	1938	14
Surrey	1:10,560	1938	15
London	1:10,560	1938	16
Ordnance Survey Plan	1:10,000	1940 - 1950	17
Ordnance Survey Plan	1:10,000	1940 - 1958	18
Historical Aerial Photography	1:10,560	1948	19
Historical Aerial Photography	1:10,560	1948	20
Ordnance Survey Plan	1:10,000	1962 - 1966	21
Ordnance Survey Plan	1:10,000	1966 - 1967	22
Ordnance Survey Plan	1:10,000	1975 - 1976	23
London	1:25,000	1985	24
Ordnance Survey Plan	1:10,000	1988	25
Ordnance Survey Plan	1:10,000	1992	26
10K Raster Mapping	1:10,000	1999	27
10K Raster Mapping	1:10,000	2006	28
VectorMap Local	1:10,000	2017	29

## Historical Map - Slice A

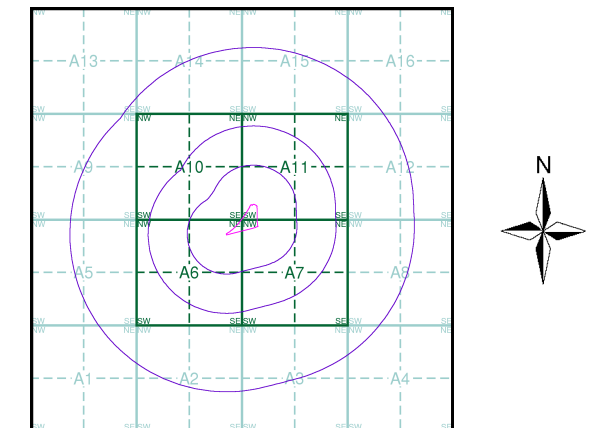

## Order Details

Order Number: 142584674\_1\_1  
 Customer Ref: Homebase, Richmond  
 National Grid Reference: 518890, 175430  
 Slice: A  
 Site Area (Ha): 1.58  
 Search Buffer (m): 1000

## Site Details

Homebase Ltd, 84, Manor Road, RICHMOND, TW9 1YB

**Landmark**  
 INFORMATION GROUP

Tel: 0844 844 9952  
 Fax: 0844 844 9951  
 Web: www.envirocheck.co.uk

# Russian Military Mapping Legends

## 1:5,000 and 1:10,000 mapping

a. Not drawn to scale b. Drawn to scale

	Government and Administrative Buildings		Military and Industrial Buildings
	Military and Communication Areas		Subway Entrance
	Fireproof Building		Prominent Fireproof Building
	Non-fireproof Building		Non-fireproof Building (non-dwelling)
	Factory, mill, and flour mill, with chimneys		Factory, mill, and flour mill, without chimneys
	Power Station, drawn to scale		Hydroelectric Power Station
	Radio Station, drawn to scale		Telephone Station, drawn to scale
	Abandoned Open-pit Mine or Quarry		Open-pit Salt Mine
	Pit		Oil Deposit or Well
	Oil Seepage		Natural Gas Tank
	Tailings Pile		Fuel Storage Tanks
	Bench Mark		Drill Hole
	Burial Mound		Triangulation Point on Burial Mound
	Single-track Railroad		Double-track Railroad
	Railroad and Station Building		Small Bridge
	Tunnel		Pipe (Culvert)
	Coniferous Forest		Deciduous Forest
	Mixed Forest		Lawns
	Citrus Orchard		Wet Ground
	Scattered Vegetation		

**243,8** Values for prominent elevations  
**186.0** Numbers for spot elevations, depth soundings, contour lines, etc.  
**0,2** Velocity of the current, width of river bed, depth of river  
**180/12** Fractional terms: length and capacity of bridges; depth of fords and condition of the river bottom; height of forest and the diameter of trees

### Russian Alphabet (For reference and phonetic interpretation of map text)

<b>А а (A)</b>	<b>З з (Z)</b>	<b>П п (P)</b>	<b>Ч ч (CH)</b>
<b>Б б (B)</b>	<b>И и (I)</b>	<b>Р р (R)</b>	<b>Ш ш (SH)</b>
<b>В в (V)</b>	<b>Й й (Y)</b>	<b>С с (S)</b>	<b>Щ щ (SHCH)</b>
<b>Г г (G)</b>	<b>К к (K)</b>	<b>Т т (T)</b>	<b>Ъ (-)</b>
<b>Д д (D)</b>	<b>Л л (L)</b>	<b>У у (U)</b>	<b>Ы (Y)</b>
<b>Е е (E)</b>	<b>М м (M)</b>	<b>Ф ф (F)</b>	<b>Ь (')</b>
<b>Ё ё (YO)</b>	<b>Н н (N)</b>	<b>Х х (KH)</b>	<b>Э э (E)</b>
<b>Ж ж (ZH)</b>	<b>О о (O)</b>	<b>Ц ц (TS)</b>	<b>Ю ю (YU or IU)</b>
			<b>Я я (YA or IA)</b>

## 1:25,000 mapping

a. Not drawn to scale b. Drawn to scale

	Government and Administrative Buildings		Military and Industrial Buildings
	Military and Communication Areas		Subway Entrance
	Partly Demolished Buildings		Demolished Buildings
	Built-Up Area with Fireproof Buildings Predominant		Built-Up Area with Non-Fireproof Buildings Predominant
	Individual Fireproof Building		Prominent Industrial Building
	Individual Dwelling, Fireproof		Ruins of an Individual Dwelling
	Factory or Mill Chimney		Factory or Mill with Chimney
	Factory or Mill without Chimney		Salt Mine
	Operating Shaft or Mine		Non-Operating Shaft or Mine
	Tailings Pile		Gas Pump or Service Station
	Fuel Storage or Natural Gas Tank		Oil or Natural Gas Derrick
	Small Hydroelectric Power Station		Power Station
	Transformer Station		Cemetery
	Burial Mound (height in metres)		Triangulation Point on Burial Mound
	Triangulation Point		Bench Mark
	Bench Mark (monumented)		Telegraph Office
	Telephone Station		Radio Station
	Radio Tower		Airfield or Seaplane Base
	Landing Strip		Cut
	Fill		Km Post
	Plantings		Width of Road
	Steep Grade		Telegraph/Telephone Lines
	Main Highway		Highway under Construction
	Improved Dirt Road (former truck road)		Small Bridge
	Pipe (Culvert)		Tunnel
	Dismantled Railroad		Double-track Railroad with First Class Station
	Railroad Under Construction		Shore Embankment
	River or Ditch with Embankment		Water Gauge
	Direction and velocity of current		Water Level Mark
	Well		Spring
	Water Reservoir or Rain Water Pit		Isobath with value
	Heavy (Index) Contour Line		Half Contour Line
	Contour Line and Value		Spot Elevation Value
	Coniferous		Deciduous
	Mixed		Scrub

## Key to Numbers on Mapping

### TQ17\_London

No.	Description
93	Factory (Gas)

# FAIRHURST

## Historical Mapping & Photography included:

Mapping Type	Scale	Date	Pg
Middlesex	1:10,560	1869 - 1873	3
Surrey	1:10,560	1871 - 1874	4
London	1:10,560	1896	5
Surrey	1:10,560	1898 - 1899	6
Middlesex	1:10,560	1920	7
Surrey	1:10,560	1920	8
London	1:10,560	1920	9
Surrey	1:10,560	1933	10
Surrey	1:10,560	1933	11
Middlesex	1:10,560	1935	12
Surrey	1:10,560	1938	13
Middlesex	1:10,560	1938	14
Surrey	1:10,560	1938	15
London	1:10,560	1938	16
Ordnance Survey Plan	1:10,000	1940 - 1950	17
Ordnance Survey Plan	1:10,000	1940 - 1958	18
Historical Aerial Photography	1:10,560	1948	19
Historical Aerial Photography	1:10,560	1948	20
Ordnance Survey Plan	1:10,000	1962 - 1966	21
Ordnance Survey Plan	1:10,000	1966 - 1967	22
Ordnance Survey Plan	1:10,000	1975 - 1976	23
London	1:25,000	1985	24
Ordnance Survey Plan	1:10,000	1988	25
Ordnance Survey Plan	1:10,000	1992	26
10K Raster Mapping	1:10,000	1999	27
10K Raster Mapping	1:10,000	2006	28
VectorMap Local	1:10,000	2017	29

## Russian Map - Slice A

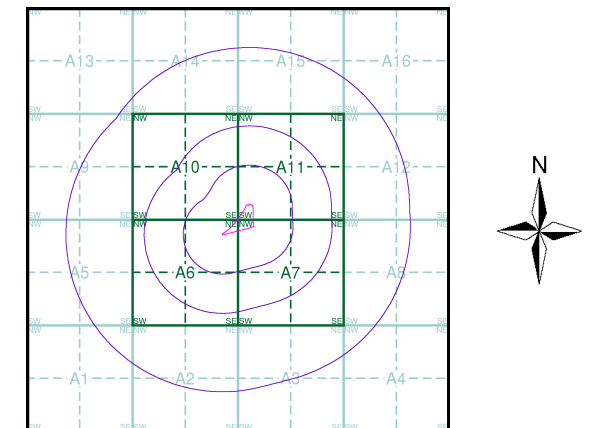

## Order Details

Order Number: 142584674\_1\_1  
 Customer Ref: Homebase, Richmond  
 National Grid Reference: 518890, 175430  
 Slice: A  
 Site Area (Ha): 1.58  
 Search Buffer (m): 1000

## Site Details

Homebase Ltd, 84, Manor Road, RICHMOND, TW9 1YB

**Landmark**  
 INFORMATION GROUP

Tel: 0844 844 9952  
 Fax: 0844 844 9951  
 Web: www.envirocheck.co.uk

# FAIRHURST

Middlesex

Published 1869 - 1873

Source map scale - 1:10,560

The historical maps shown were reproduced from maps predominantly held at the scale adopted for England, Wales and Scotland in the 1840's. In 1854 the 1:2,500 scale was adopted for mapping urban areas; these maps were used to update the 1:10,560 maps. The published date given therefore is often some years later than the surveyed date. Before 1938, all OS maps were based on the Cassini Projection, with independent surveys of a single county or group of counties, giving rise to significant inaccuracies in outlying areas. In the late 1940's, a Provisional Edition was produced, which updated the 1:10,560 mapping from a number of sources. The maps appear unfinished - with all military camps and other strategic sites removed. These maps were initially overprinted with the National Grid. In 1970, the first 1:10,000 maps were produced using the Transverse Mercator Projection. The revision process continued until recently, with new editions appearing every 10 years or so for urban areas.

## Map Name(s) and Date(s)

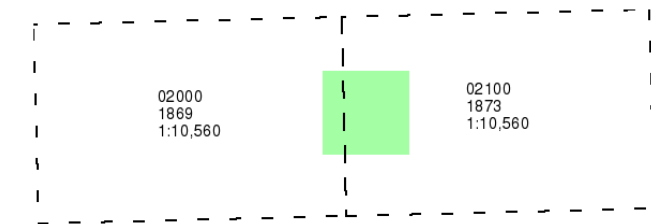

## Historical Map - Slice A

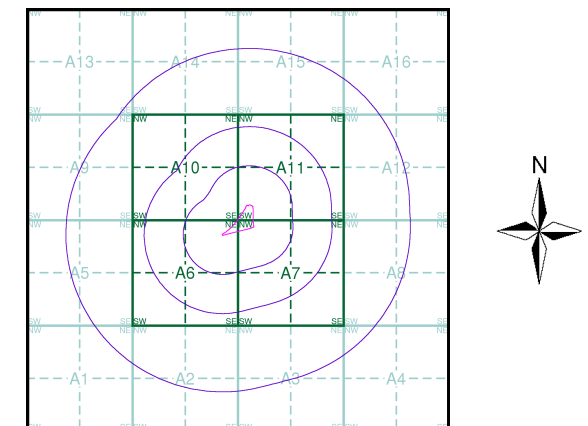

## Order Details

Order Number: 142584674\_1\_1  
Customer Ref: Homebase, Richmond  
National Grid Reference: 518890, 175430  
Slice: A  
Site Area (Ha): 1.58  
Search Buffer (m): 1000

## Site Details

Homebase Ltd, 84, Manor Road, RICHMOND, TW9 1YB

**Landmark**  
INFORMATION GROUP

Tel: 0844 844 9952  
Fax: 0844 844 9951  
Web: www.envirocheck.co.uk

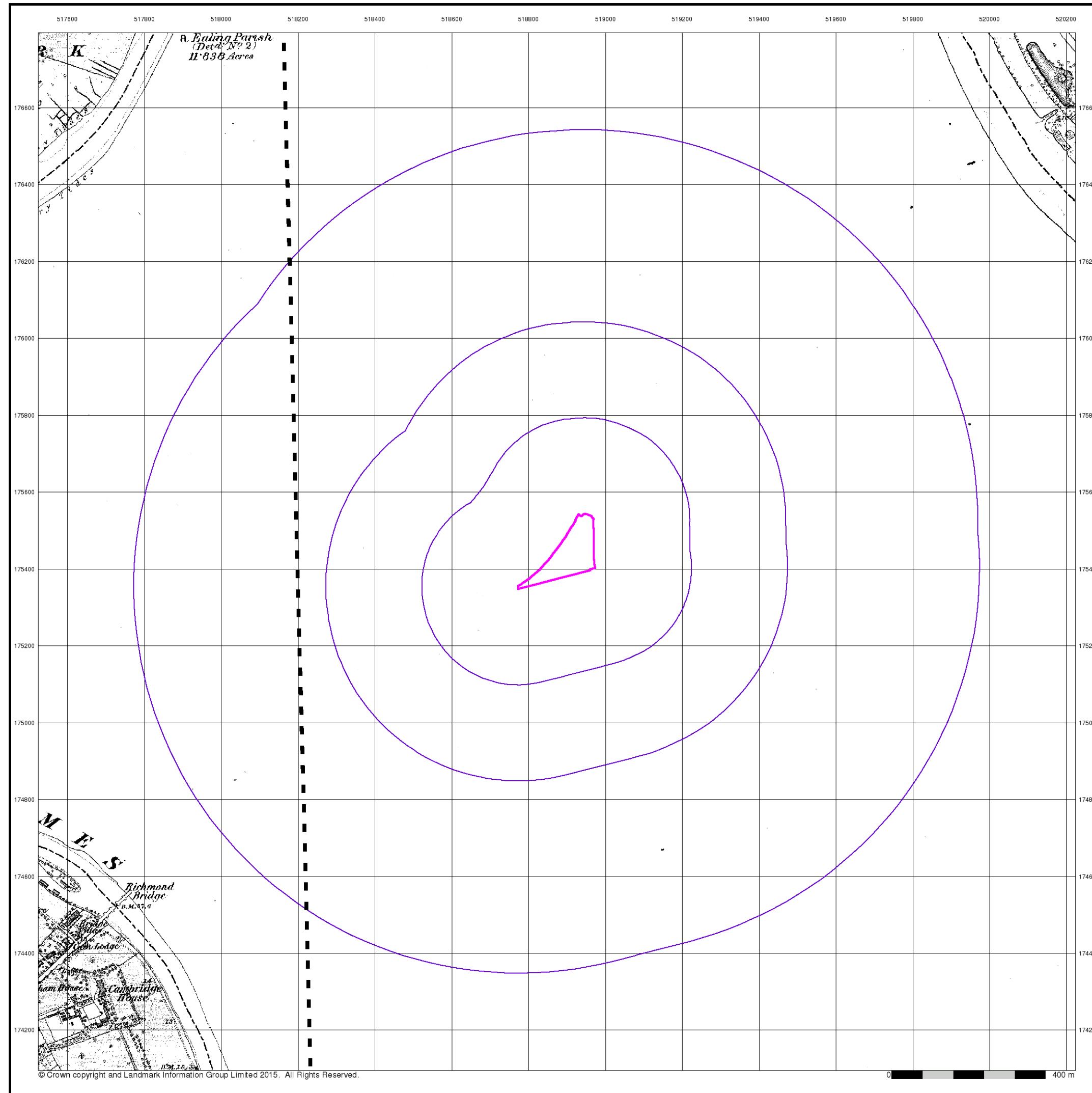



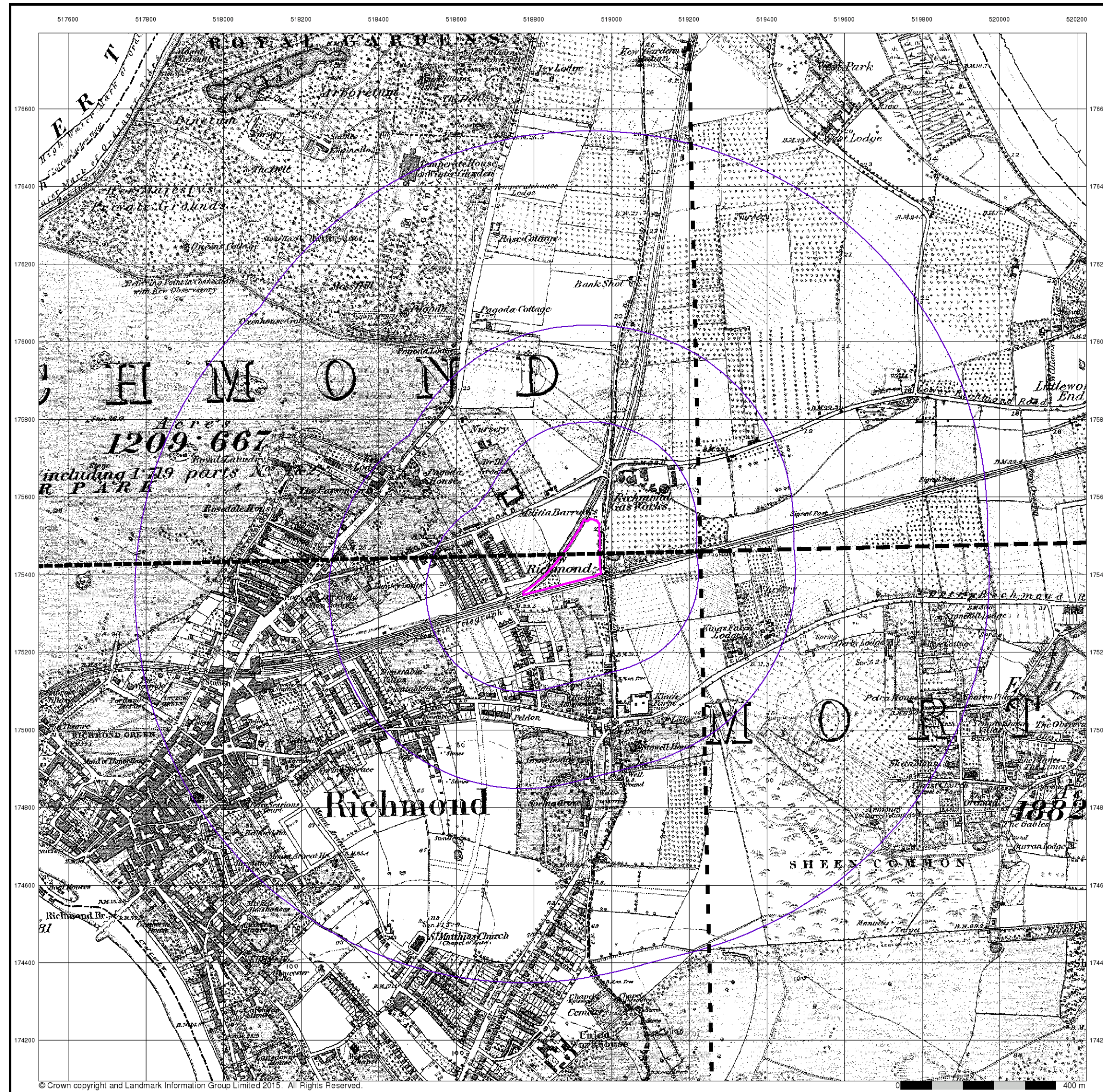

# FAIRHURST

**Surrey**  
**Published 1871 - 1874**  
**Source map scale - 1:10,560**

The historical maps shown were reproduced from maps predominantly held at the scale adopted for England, Wales and Scotland in the 1840's. In 1854 the 1:2,500 scale was adopted for mapping urban areas; these maps were used to update the 1:10,560 maps. The published date given therefore is often some years later than the surveyed date. Before 1938, all OS maps were based on the Cassini Projection, with independent surveys of a single county or group of counties, giving rise to significant inaccuracies in outlying areas. In the late 1940's, a Provisional Edition was produced, which updated the 1:10,560 mapping from a number of sources. The maps appear unfinished - with all military camps and other strategic sites removed. These maps were initially overprinted with the National Grid. In 1970, the first 1:10,000 maps were produced using the Transverse Mercator Projection. The revision process continued until recently, with new editions appearing every 10 years or so for urban areas.

### Map Name(s) and Date(s)

00100 1871 1:10,560	00200 1874 1:10,560
00600 1871 1:10,560	00700 1874 1:10,560

### Historical Map - Slice A

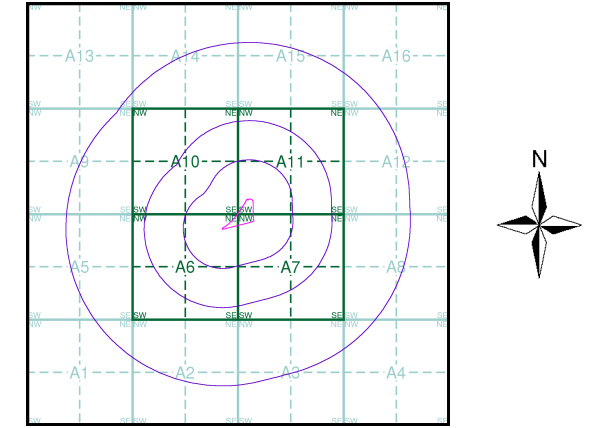

### Order Details

Order Number: 142584674\_1\_1  
 Customer Ref: Homebase, Richmond  
 National Grid Reference: 518890, 175430  
 Slice: A  
 Site Area (Ha): 1.58  
 Search Buffer (m): 1000

### Site Details

Homebase Ltd, 84, Manor Road, RICHMOND, TW9 1YB

**Landmark**  
 INFORMATION GROUP

Tel: 0844 844 9952  
 Fax: 0844 844 9951  
 Web: www.envirocheck.co.uk



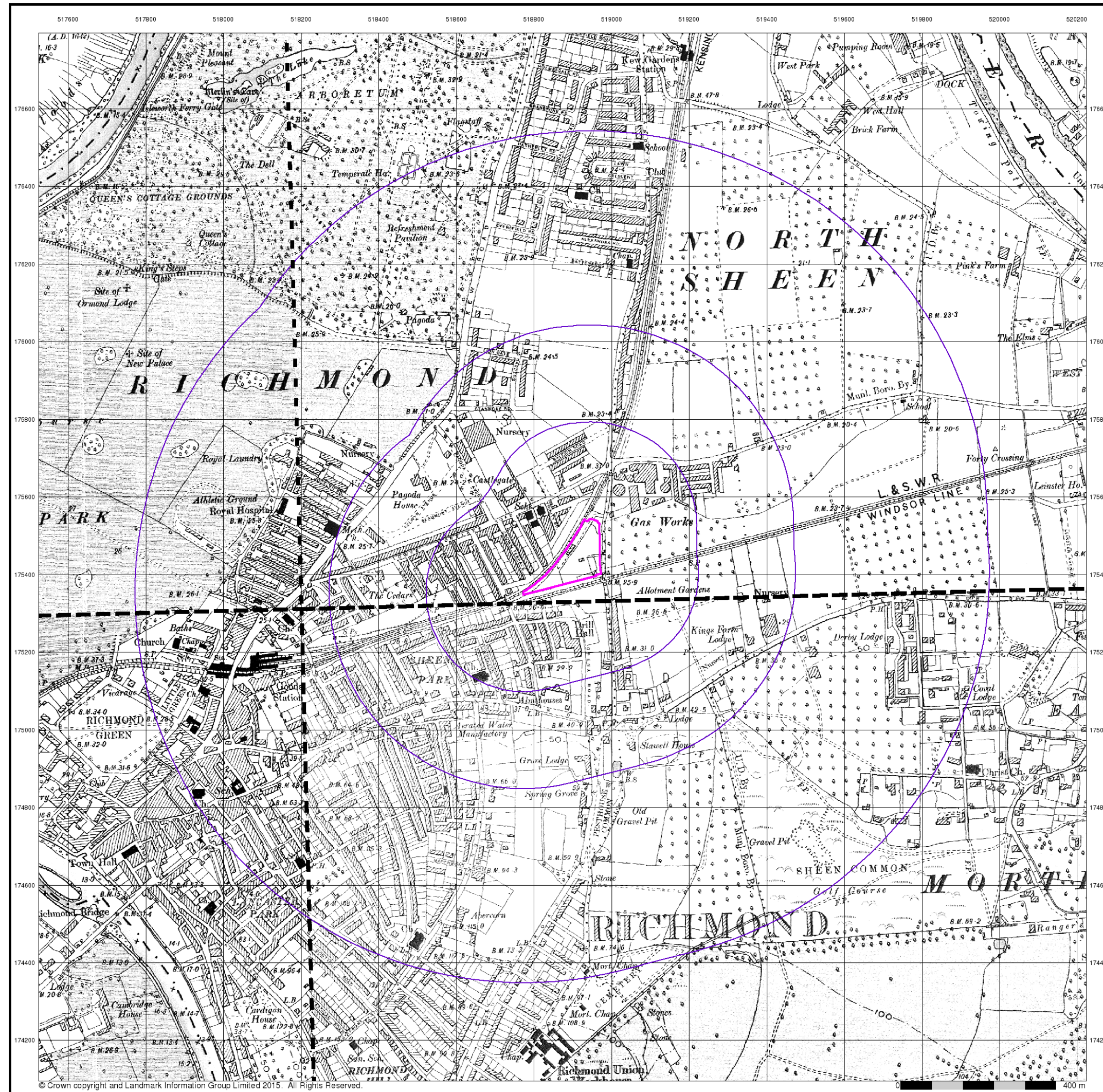

# FAIRHURST

**London**  
**Published 1896**  
**Source map scale - 1:10,560**

The historical maps shown were reproduced from maps predominantly held at the scale adopted for England, Wales and Scotland in the 1840's. In 1854 the 1:2,500 scale was adopted for mapping urban areas; these maps were used to update the 1:10,560 maps. The published date given therefore is often some years later than the surveyed date. Before 1938, all OS maps were based on the Cassini Projection, with independent surveys of a single county or group of counties, giving rise to significant inaccuracies in outlying areas. In the late 1940's, a Provisional Edition was produced, which updated the 1:10,560 mapping from a number of sources. The maps appear unfinished - with all military camps and other strategic sites removed. These maps were initially overprinted with the National Grid. In 1970, the first 1:10,000 maps were produced using the Transverse Mercator Projection. The revision process continued until recently, with new editions appearing every 10 years or so for urban areas.

### Map Name(s) and Date(s)

009NE 1896 1:10,560	010NW 1896 1:10,560
009SE 1896 1:10,560	010SW 1896 1:10,560

### Historical Map - Slice A

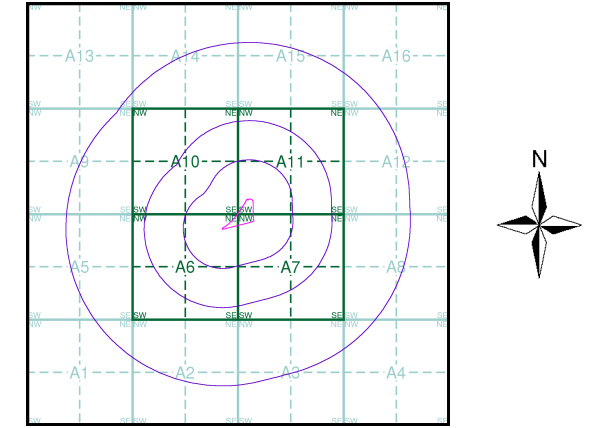

### Order Details

Order Number: 142584674\_1\_1  
 Customer Ref: Homebase, Richmond  
 National Grid Reference: 518890, 175430  
 Slice: A  
 Site Area (Ha): 1.58  
 Search Buffer (m): 1000

### Site Details

Homebase Ltd, 84, Manor Road, RICHMOND, TW9 1YB



Tel: 0844 844 9952  
 Fax: 0844 844 9951  
 Web: www.envirocheck.co.uk



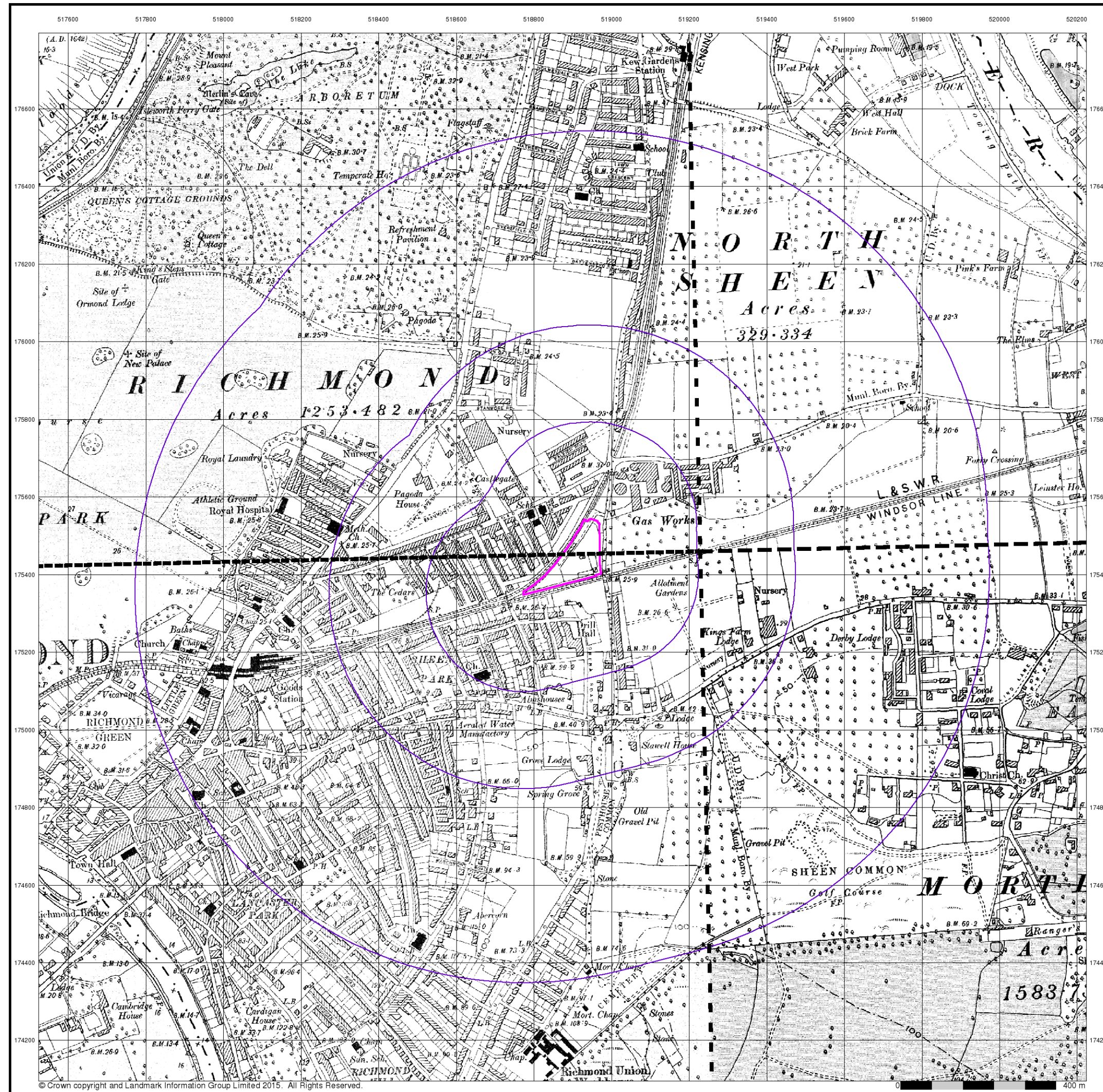

# FAIRHURST

**Surrey**  
**Published 1898 - 1899**  
**Source map scale - 1:10,560**

The historical maps shown were reproduced from maps predominantly held at the scale adopted for England, Wales and Scotland in the 1840's. In 1854 the 1:2,500 scale was adopted for mapping urban areas; these maps were used to update the 1:10,560 maps. The published date given therefore is often some years later than the surveyed date. Before 1938, all OS maps were based on the Cassini Projection, with independent surveys of a single county or group of counties, giving rise to significant inaccuracies in outlying areas. In the late 1940's, a Provisional Edition was produced, which updated the 1:10,560 mapping from a number of sources. The maps appear unfinished - with all military camps and other strategic sites removed. These maps were initially overprinted with the National Grid. In 1970, the first 1:10,000 maps were produced using the Transverse Mercator Projection. The revision process continued until recently, with new editions appearing every 10 years or so for urban areas.

### Map Name(s) and Date(s)

001SE 1898 1:10,560	002SW 1898 1:10,560
006NE 1898 1:10,560	007NW 1899 1:10,560

### Historical Map - Slice A

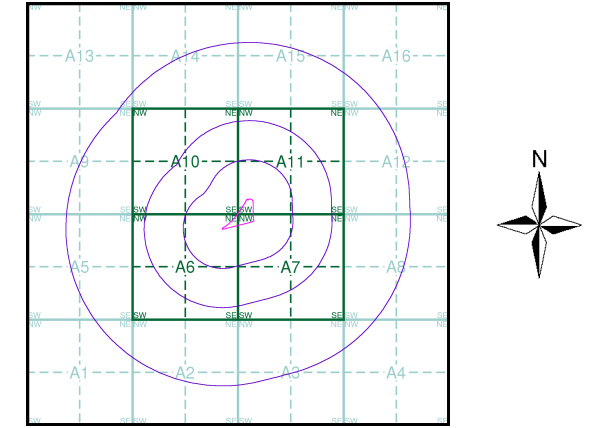

### Order Details

Order Number: 142584674\_1\_1  
 Customer Ref: Homebase, Richmond  
 National Grid Reference: 518890, 175430  
 Slice: A  
 Site Area (Ha): 1.58  
 Search Buffer (m): 1000

### Site Details

Homebase Ltd, 84, Manor Road, RICHMOND, TW9 1YB

**Landmark**  
 INFORMATION GROUP

Tel: 0844 844 9952  
 Fax: 0844 844 9951  
 Web: www.envirocheck.co.uk



# FAIRHURST

Middlesex

Published 1920

Source map scale - 1:10,560

The historical maps shown were reproduced from maps predominantly held at the scale adopted for England, Wales and Scotland in the 1840's. In 1854 the 1:2,500 scale was adopted for mapping urban areas; these maps were used to update the 1:10,560 maps. The published date given therefore is often some years later than the surveyed date. Before 1938, all OS maps were based on the Cassini Projection, with independent surveys of a single county or group of counties, giving rise to significant inaccuracies in outlying areas. In the late 1940's, a Provisional Edition was produced, which updated the 1:10,560 mapping from a number of sources. The maps appear unfinished - with all military camps and other strategic sites removed. These maps were initially overprinted with the National Grid. In 1970, the first 1:10,000 maps were produced using the Transverse Mercator Projection. The revision process continued until recently, with new editions appearing every 10 years or so for urban areas.

### Map Name(s) and Date(s)

020NE	1920	1:10,560	
020SE	1920	1:10,560	

### Historical Map - Slice A

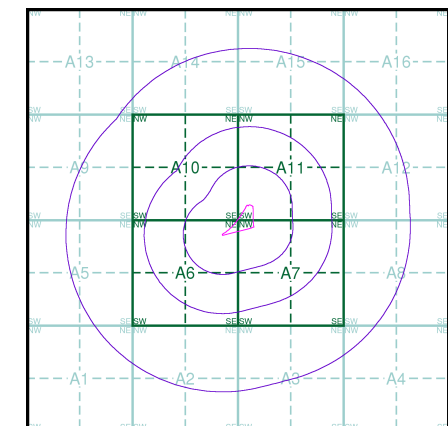

### Order Details

Order Number: 142584674\_1\_1  
 Customer Ref: Homebase, Richmond  
 National Grid Reference: 518890, 175430  
 Slice: A  
 Site Area (Ha): 1.58  
 Search Buffer (m): 1000

### Site Details

Homebase Ltd, 84, Manor Road, RICHMOND, TW9 1YB

**Landmark**  
 INFORMATION GROUP

Tel: 0844 844 9952  
 Fax: 0844 844 9951  
 Web: www.envirocheck.co.uk

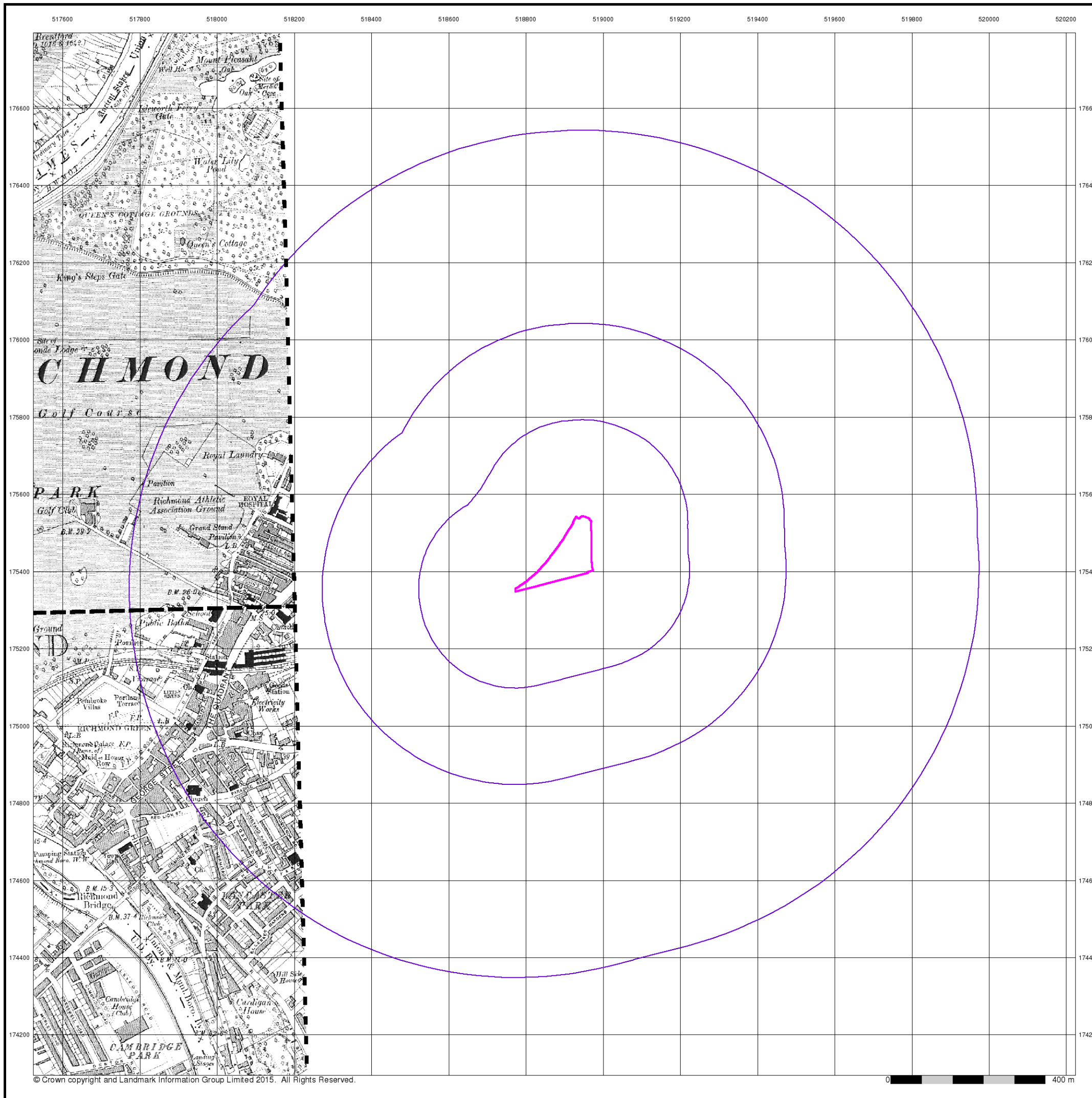



# FAIRHURST

Surrey

Published 1920

Source map scale - 1:10,560

The historical maps shown were reproduced from maps predominantly held at the scale adopted for England, Wales and Scotland in the 1840's. In 1854 the 1:2,500 scale was adopted for mapping urban areas; these maps were used to update the 1:10,560 maps. The published date given therefore is often some years later than the surveyed date. Before 1938, all OS maps were based on the Cassini Projection, with independent surveys of a single county or group of counties, giving rise to significant inaccuracies in outlying areas. In the late 1940's, a Provisional Edition was produced, which updated the 1:10,560 mapping from a number of sources. The maps appear unfinished - with all military camps and other strategic sites removed. These maps were initially overprinted with the National Grid. In 1970, the first 1:10,000 maps were produced using the Transverse Mercator Projection. The revision process continued until recently, with new editions appearing every 10 years or so for urban areas.

## Map Name(s) and Date(s)

001SE 1920 1:10,560	002SW 1920 1:10,560
006NE 1920 1:10,560	007NW 1920 1:10,560

## Historical Map - Slice A

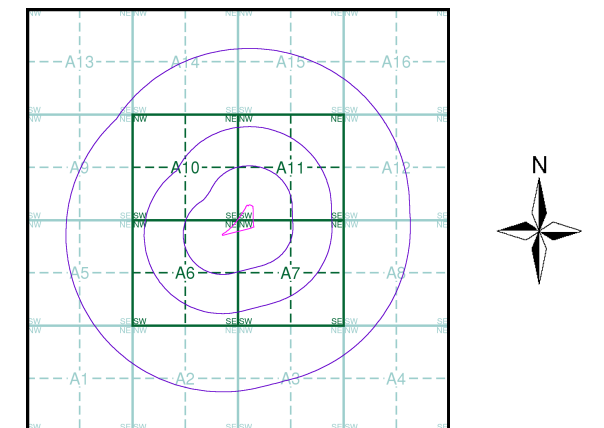

## Order Details

Order Number: 142584674\_1\_1  
 Customer Ref: Homebase, Richmond  
 National Grid Reference: 518890, 175430  
 Slice: A  
 Site Area (Ha): 1.58  
 Search Buffer (m): 1000

## Site Details

Homebase Ltd, 84, Manor Road, RICHMOND, TW9 1YB

**Landmark**  
 INFORMATION GROUP

Tel: 0844 844 9952  
 Fax: 0844 844 9951  
 Web: www.envirocheck.co.uk

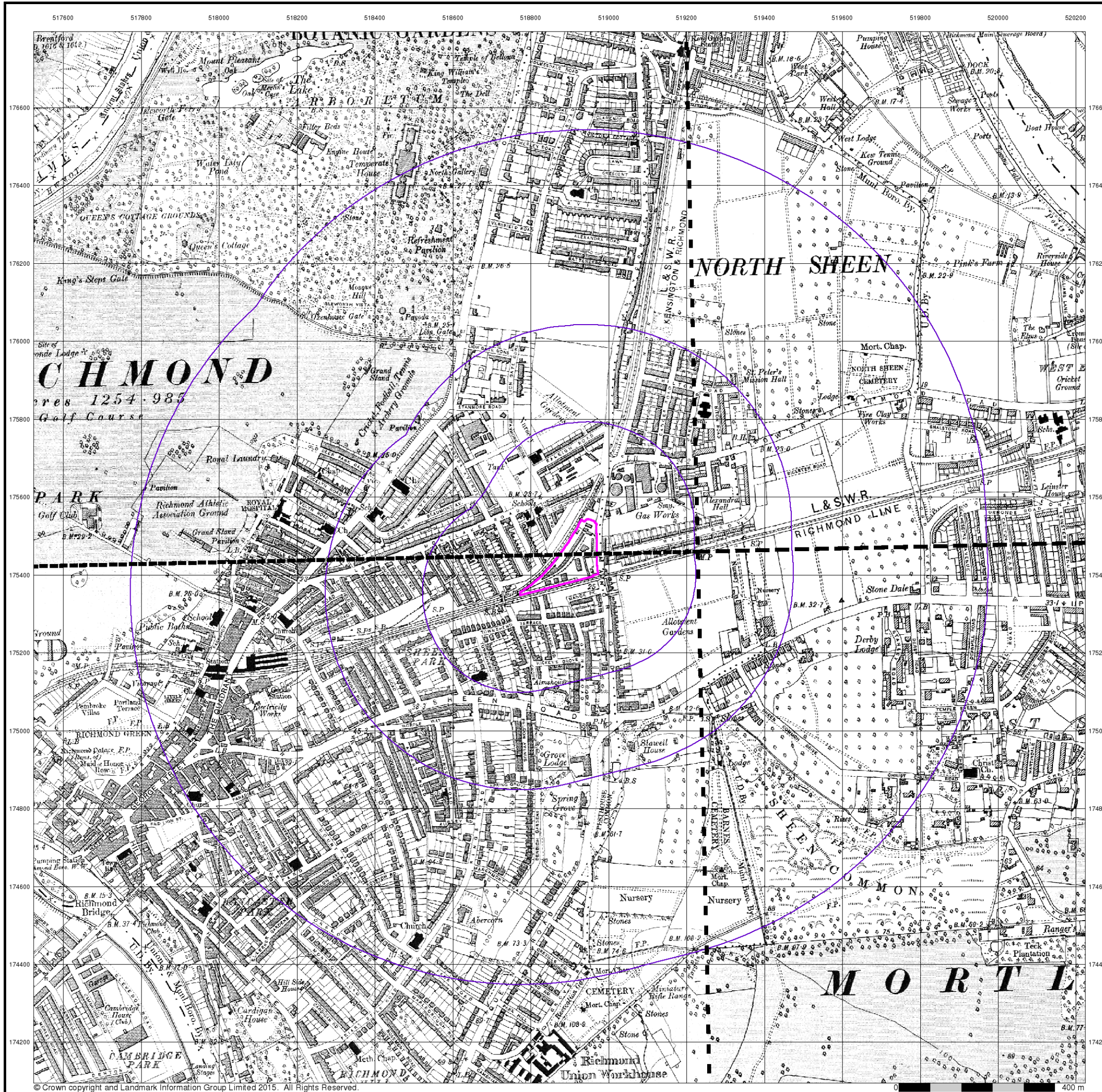



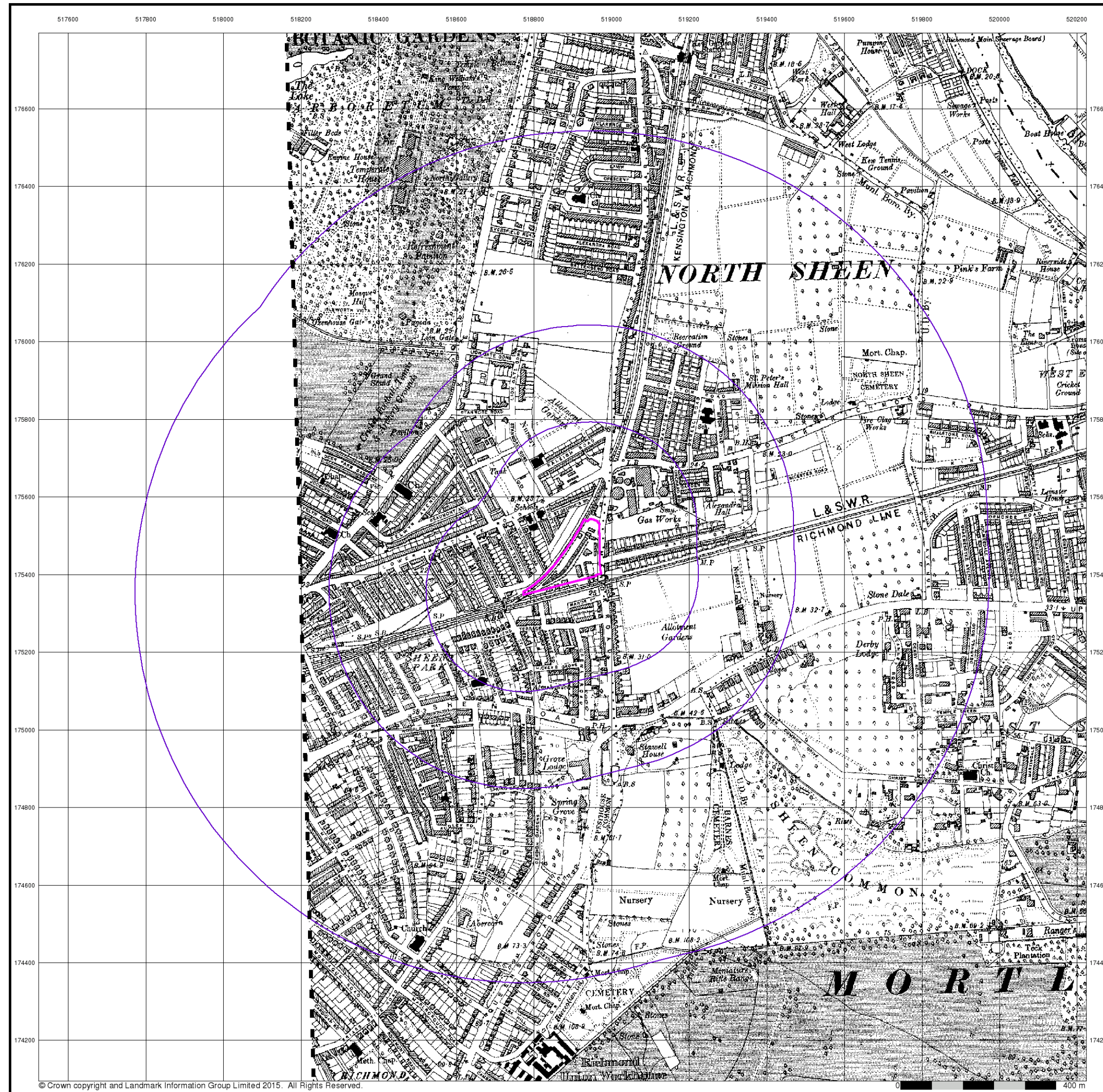

# FAIRHURST

**London**  
**Published 1920**  
**Source map scale - 1:10,560**

The historical maps shown were reproduced from maps predominantly held at the scale adopted for England, Wales and Scotland in the 1840's. In 1854 the 1:2,500 scale was adopted for mapping urban areas; these maps were used to update the 1:10,560 maps. The published date given therefore is often some years later than the surveyed date. Before 1938, all OS maps were based on the Cassini Projection, with independent surveys of a single county or group of counties, giving rise to significant inaccuracies in outlying areas. In the late 1940's, a Provisional Edition was produced, which updated the 1:10,560 mapping from a number of sources. The maps appear unfinished - with all military camps and other strategic sites removed. These maps were initially overprinted with the National Grid. In 1970, the first 1:10,000 maps were produced using the Transverse Mercator Projection. The revision process continued until recently, with new editions appearing every 10 years or so for urban areas.

### Map Name(s) and Date(s)

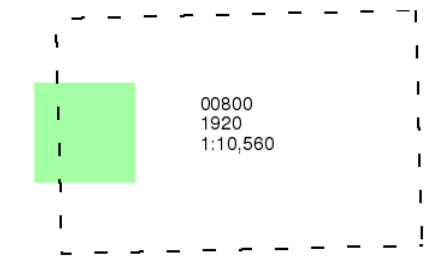

### Historical Map - Slice A

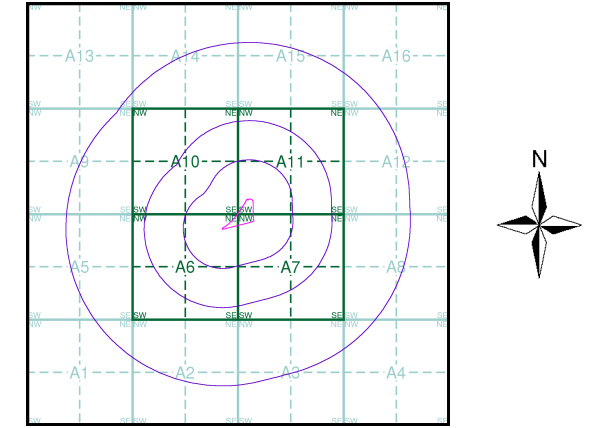

### Order Details

Order Number: 142584674\_1\_1  
 Customer Ref: Homebase, Richmond  
 National Grid Reference: 518890, 175430  
 Slice: A  
 Site Area (Ha): 1.58  
 Search Buffer (m): 1000

### Site Details

Homebase Ltd, 84, Manor Road, RICHMOND, TW9 1YB



Tel: 0844 844 9952  
 Fax: 0844 844 9951  
 Web: www.envirocheck.co.uk





# FAIRHURST

Surrey

Published 1933

Source map scale - 1:10,560

The historical maps shown were reproduced from maps predominantly held at the scale adopted for England, Wales and Scotland in the 1840's. In 1854 the 1:2,500 scale was adopted for mapping urban areas; these maps were used to update the 1:10,560 maps. The published date given therefore is often some years later than the surveyed date. Before 1938, all OS maps were based on the Cassini Projection, with independent surveys of a single county or group of counties, giving rise to significant inaccuracies in outlying areas. In the late 1940's, a Provisional Edition was produced, which updated the 1:10,560 mapping from a number of sources. The maps appear unfinished - with all military camps and other strategic sites removed. These maps were initially overprinted with the National Grid. In 1970, the first 1:10,000 maps were produced using the Transverse Mercator Projection. The revision process continued until recently, with new editions appearing every 10 years or so for urban areas.

### Map Name(s) and Date(s)

001SE 1933 1:10,560	002SW 1933 1:10,560
006NE 1933 1:10,560	007NW 1933 1:10,560

### Historical Map - Slice A

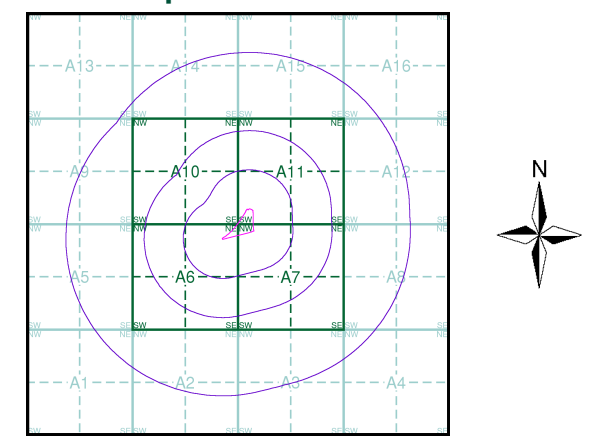

### Order Details

Order Number: 142584674\_1\_1  
 Customer Ref: Homebase, Richmond  
 National Grid Reference: 518890, 175430  
 Slice: A  
 Site Area (Ha): 1.58  
 Search Buffer (m): 1000

### Site Details

Homebase Ltd, 84, Manor Road, RICHMOND, TW9 1YB

**Landmark**  
 INFORMATION GROUP

Tel: 0844 844 9952  
 Fax: 0844 844 9951  
 Web: www.envirocheck.co.uk



517600 517800 518000 518200 518400 518600 518800 519000 519200 519400 519600 519800 520000 520200

# FAIRHURST

Surrey

Published 1933

Source map scale - 1:10,560

The historical maps shown were reproduced from maps predominantly held at the scale adopted for England, Wales and Scotland in the 1840's. In 1854 the 1:2,500 scale was adopted for mapping urban areas; these maps were used to update the 1:10,560 maps. The published date given therefore is often some years later than the surveyed date. Before 1938, all OS maps were based on the Cassini Projection, with independent surveys of a single county or group of counties, giving rise to significant inaccuracies in outlying areas. In the late 1940's, a Provisional Edition was produced, which updated the 1:10,560 mapping from a number of sources. The maps appear unfinished - with all military camps and other strategic sites removed. These maps were initially overprinted with the National Grid. In 1970, the first 1:10,000 maps were produced using the Transverse Mercator Projection. The revision process continued until recently, with new editions appearing every 10 years or so for urban areas.

### Map Name(s) and Date(s)

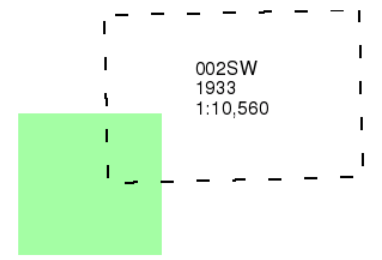

### Historical Map - Slice A

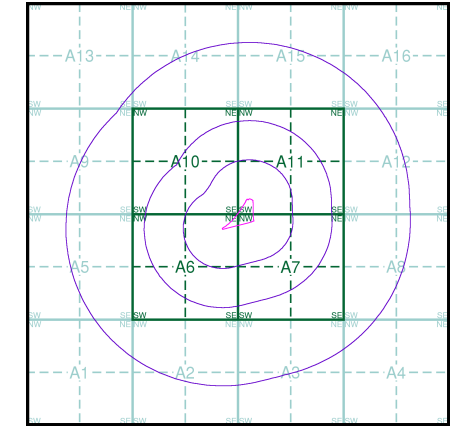

### Order Details

Order Number: 142584674\_1\_1  
Customer Ref: Homebase, Richmond  
National Grid Reference: 518890, 175430  
Slice: A  
Site Area (Ha): 1.58  
Search Buffer (m): 1000

### Site Details

Homebase Ltd, 84, Manor Road, RICHMOND, TW9 1YB

Landmark  
INFORMATION GROUP

Tel: 0844 844 9952  
Fax: 0844 844 9951  
Web: www.envirocheck.co.uk

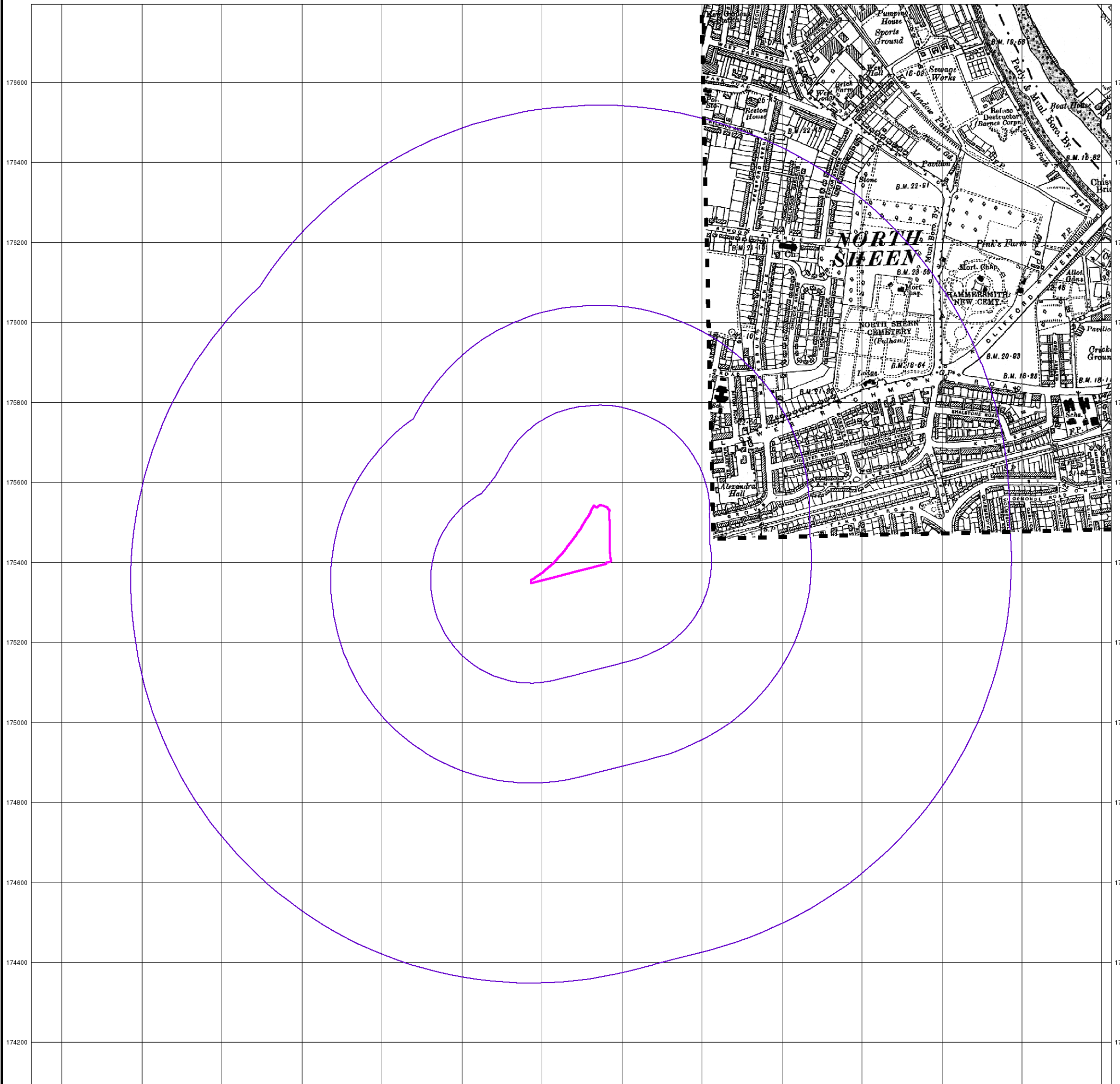



# FAIRHURST

Middlesex

Published 1935

Source map scale - 1:10,560

The historical maps shown were reproduced from maps predominantly held at the scale adopted for England, Wales and Scotland in the 1840's. In 1854 the 1:2,500 scale was adopted for mapping urban areas; these maps were used to update the 1:10,560 maps. The published date given therefore is often some years later than the surveyed date. Before 1938, all OS maps were based on the Cassini Projection, with independent surveys of a single county or group of counties, giving rise to significant inaccuracies in outlying areas. In the late 1940's, a Provisional Edition was produced, which updated the 1:10,560 mapping from a number of sources. The maps appear unfinished - with all military camps and other strategic sites removed. These maps were initially overprinted with the National Grid. In 1970, the first 1:10,000 maps were produced using the Transverse Mercator Projection. The revision process continued until recently, with new editions appearing every 10 years or so for urban areas.

### Map Name(s) and Date(s)

020NE	1935	1:10,560
020SE	1935	1:10,560

### Historical Map - Slice A

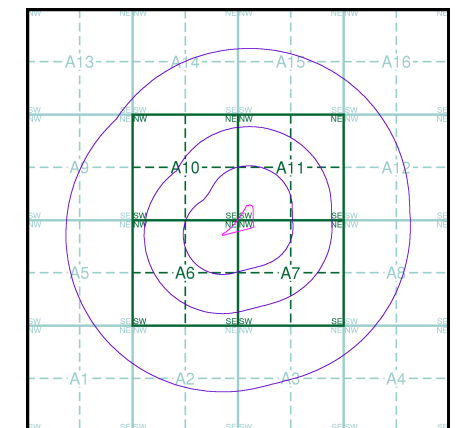

### Order Details

Order Number: 142584674\_1\_1  
Customer Ref: Homebase, Richmond  
National Grid Reference: 518890, 175430  
Slice: A  
Site Area (Ha): 1.58  
Search Buffer (m): 1000

### Site Details

Homebase Ltd, 84, Manor Road, RICHMOND, TW9 1YB

Landmark  
INFORMATION GROUP

Tel: 0844 844 9952  
Fax: 0844 844 9951  
Web: www.envirocheck.co.uk

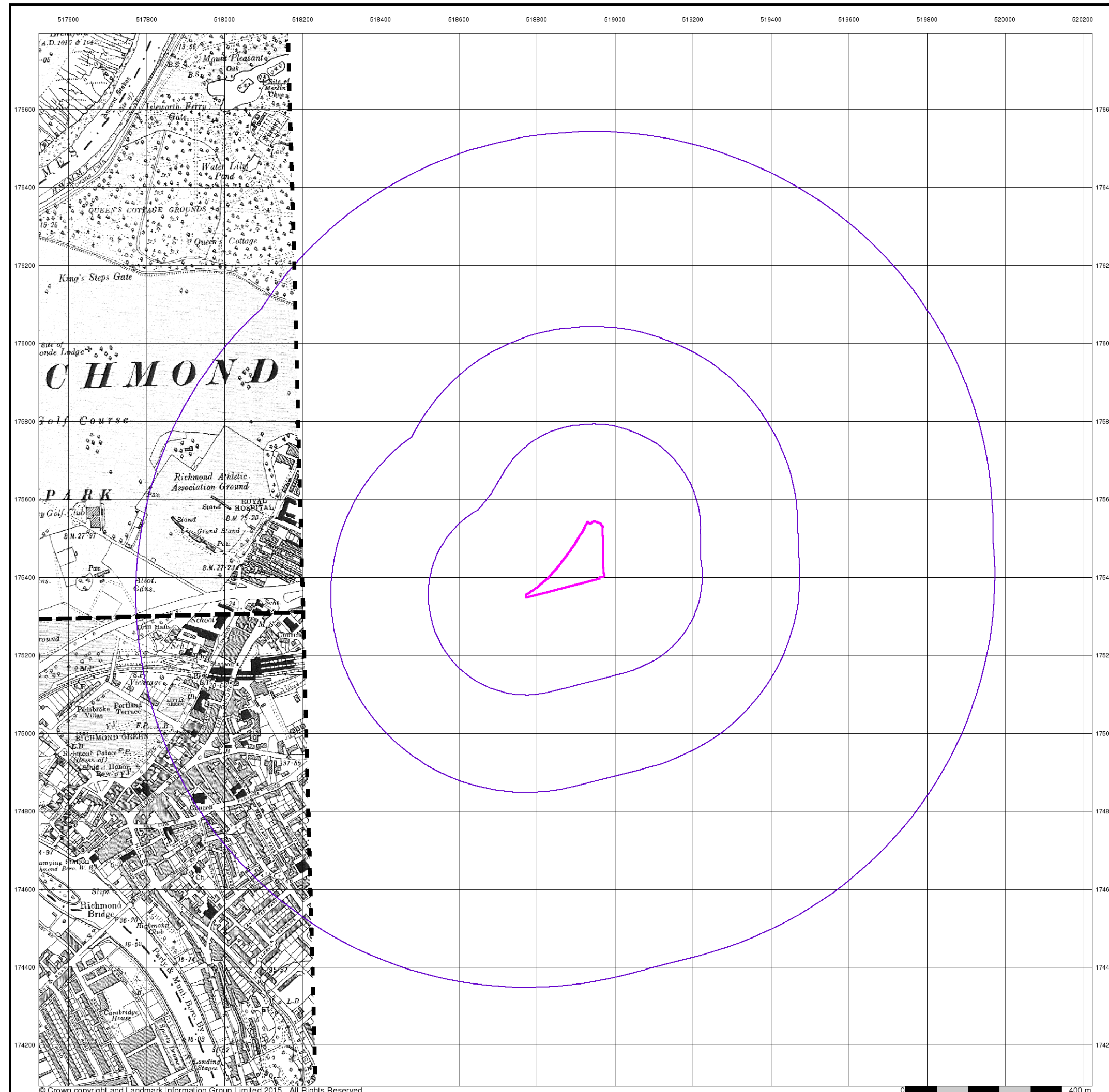



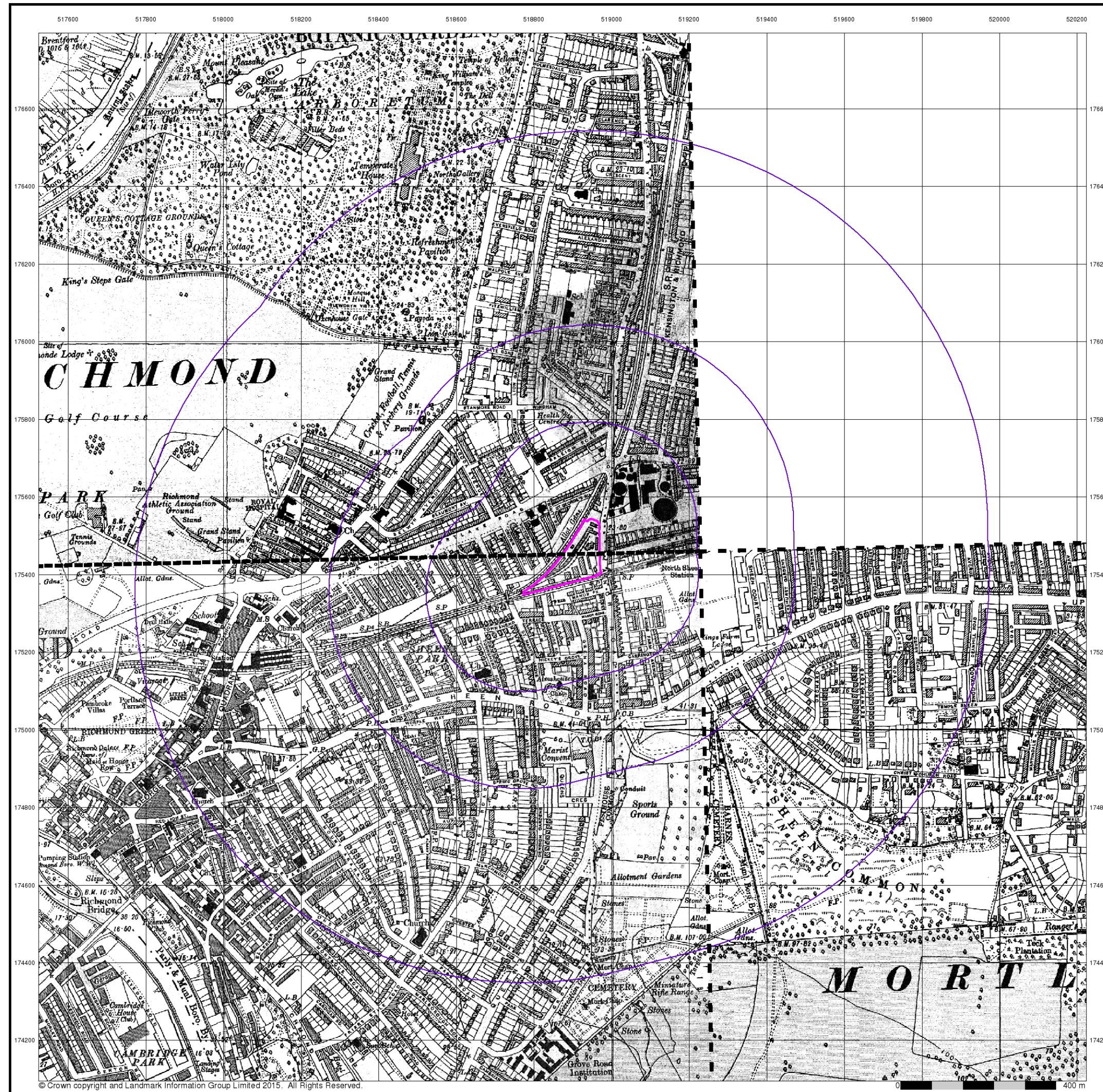

# FAIRHURST

**Surrey**  
**Published 1938**  
**Source map scale - 1:10,560**

The historical maps shown were reproduced from maps predominantly held at the scale adopted for England, Wales and Scotland in the 1840's. In 1854 the 1:2,500 scale was adopted for mapping urban areas; these maps were used to update the 1:10,560 maps. The published date given therefore is often some years later than the surveyed date. Before 1938, all OS maps were based on the Cassini Projection, with independent surveys of a single county or group of counties, giving rise to significant inaccuracies in outlying areas. In the late 1940's, a Provisional Edition was produced, which updated the 1:10,560 mapping from a number of sources. The maps appear unfinished - with all military camps and other strategic sites removed. These maps were initially overprinted with the National Grid. In 1970, the first 1:10,000 maps were produced using the Transverse Mercator Projection. The revision process continued until recently, with new editions appearing every 10 years or so for urban areas.

### Map Name(s) and Date(s)

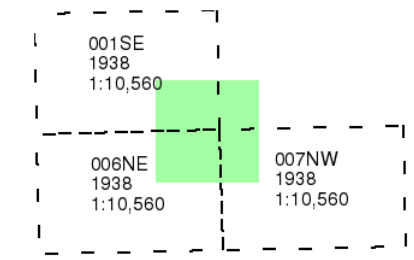

### Historical Map - Slice A

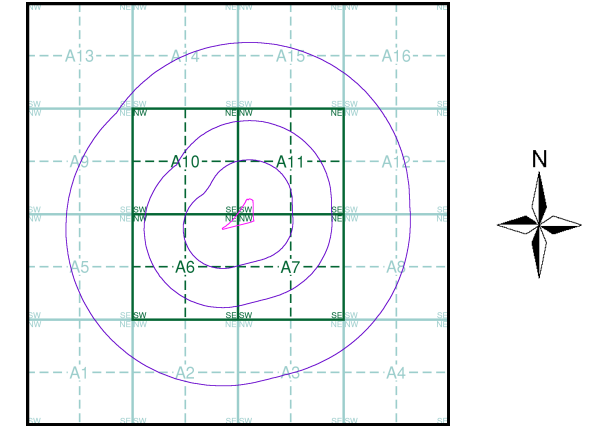

**Order Details**  
 Order Number: 142584674\_1\_1  
 Customer Ref: Homebase, Richmond  
 National Grid Reference: 518890, 175430  
 Slice: A  
 Site Area (Ha): 1.58  
 Search Buffer (m): 1000

**Site Details**  
 Homebase Ltd, 84, Manor Road, RICHMOND, TW9 1YB

**Landmark**  
 INFORMATION GROUP  
 Tel: 0844 844 9952  
 Fax: 0844 844 9951  
 Web: www.envirocheck.co.uk



# FAIRHURST

Middlesex

Published 1938

Source map scale - 1:10,560

The historical maps shown were reproduced from maps predominantly held at the scale adopted for England, Wales and Scotland in the 1840's. In 1854 the 1:2,500 scale was adopted for mapping urban areas; these maps were used to update the 1:10,560 maps. The published date given therefore is often some years later than the surveyed date. Before 1938, all OS maps were based on the Cassini Projection, with independent surveys of a single county or group of counties, giving rise to significant inaccuracies in outlying areas. In the late 1940's, a Provisional Edition was produced, which updated the 1:10,560 mapping from a number of sources. The maps appear unfinished - with all military camps and other strategic sites removed. These maps were initially overprinted with the National Grid. In 1970, the first 1:10,000 maps were produced using the Transverse Mercator Projection. The revision process continued until recently, with new editions appearing every 10 years or so for urban areas.

### Map Name(s) and Date(s)

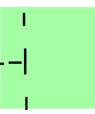
020NE	1938	1:10,560	
020SE	1938	1:10,560	

### Historical Map - Slice A

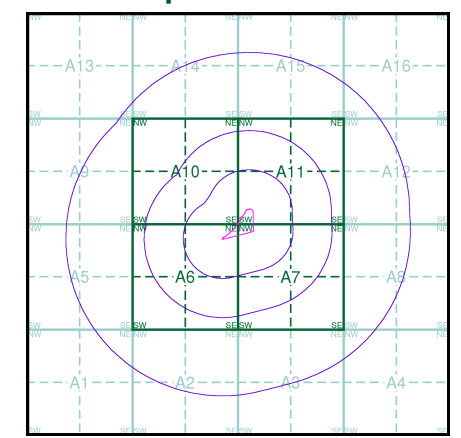

### Order Details

Order Number: 142584674\_1\_1  
 Customer Ref: Homebase, Richmond  
 National Grid Reference: 518890, 175430  
 Slice: A  
 Site Area (Ha): 1.58  
 Search Buffer (m): 1000

### Site Details

Homebase Ltd, 84, Manor Road, RICHMOND, TW9 1YB

**Landmark**  
 INFORMATION GROUP

Tel: 0844 844 9952  
 Fax: 0844 844 9951  
 Web: www.envirocheck.co.uk

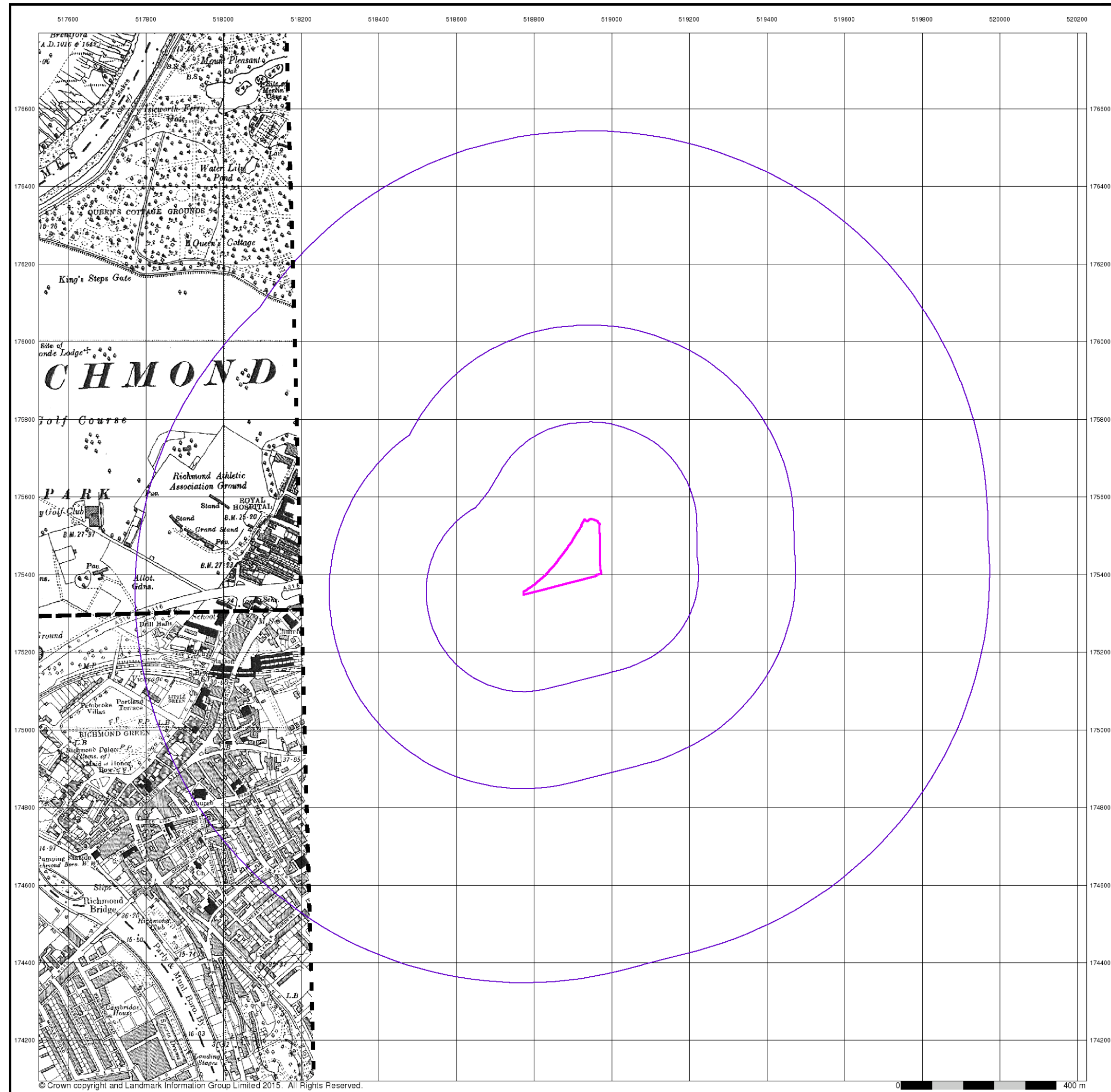

© Crown copyright and Landmark Information Group Limited 2015. All Rights Reserved.