

5.35 Communal roof terraces

The roof terraces offer a private outdoor amenity space for residents, providing a unique and tranquil place on the top of the buildings. The design of each, feature a series of enclosed spaces defined for different uses. The simplicity of shapes is delineated by the disposition of raised planters which will provide protection from the wind while adding seasonal interest.

A combination of dining areas, with flexible spaces that could be either dedicated for yoga classes or other types of sports, or either as a stage for small theatre shows for children, is proposed. Calm spaces are provided with chaise longues to contemplate the view, or enclosed spaces with seating elements.

The material palette is simple, with the use of timber decking, concrete textured paving on pedestals, and timber in all the furniture.

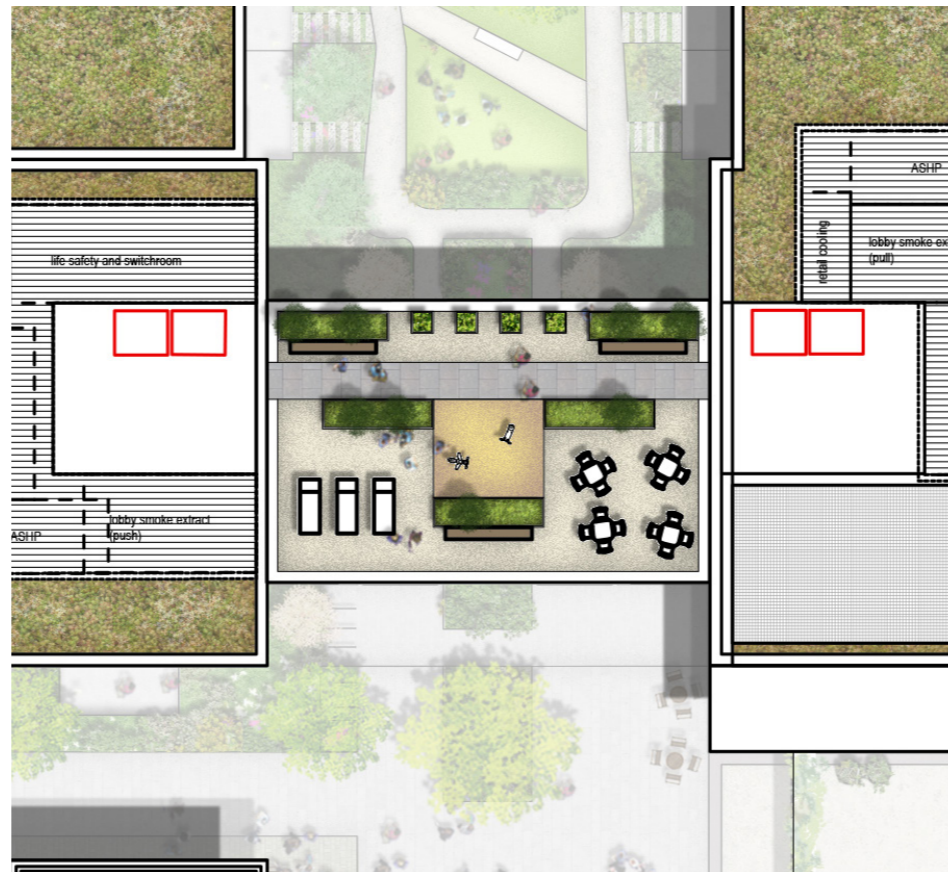

1 Block A communal roof terrace

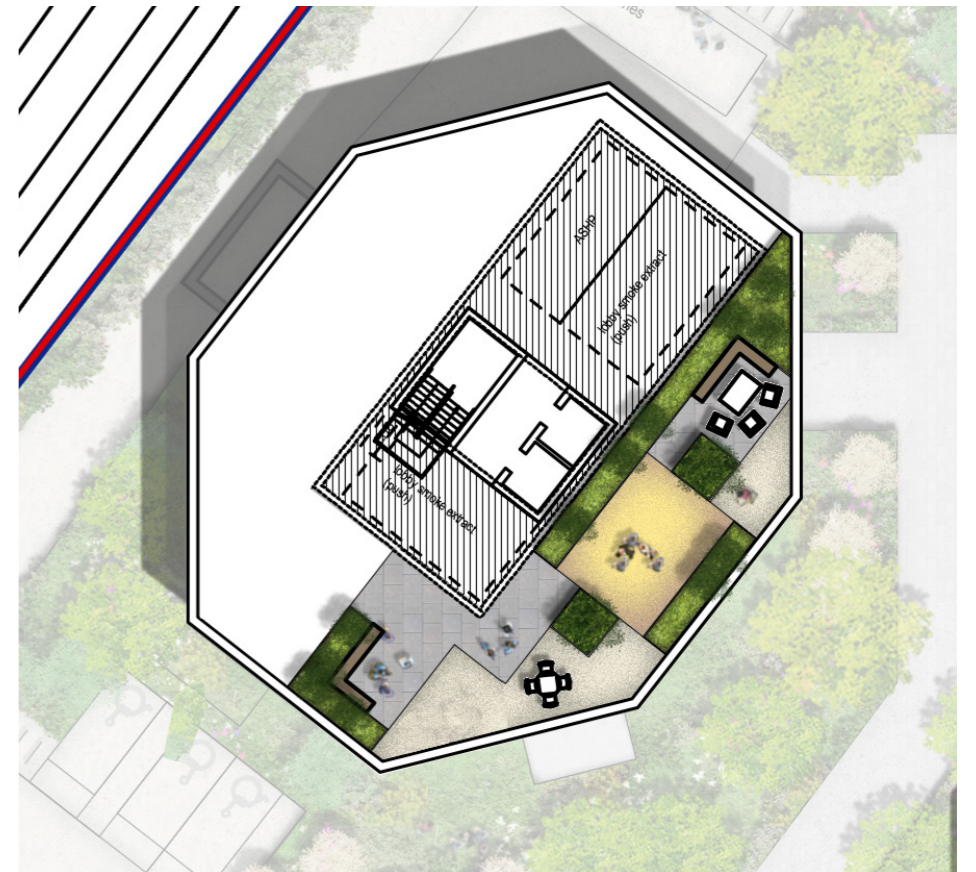

2 Block B communal roof terrace

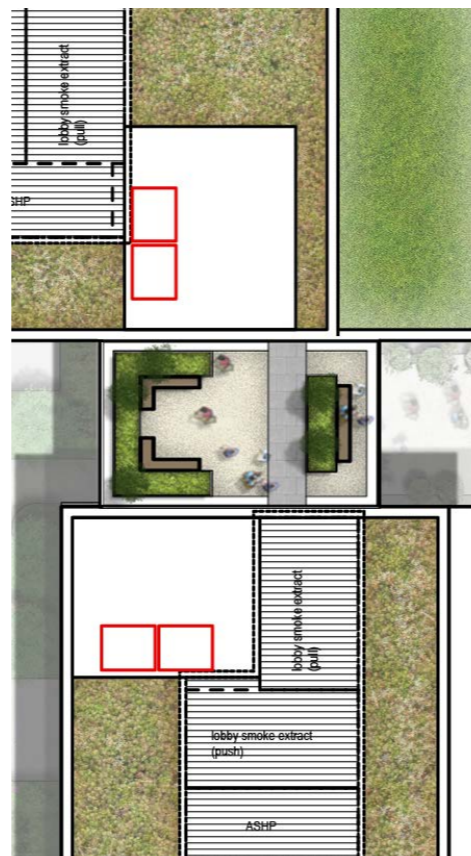
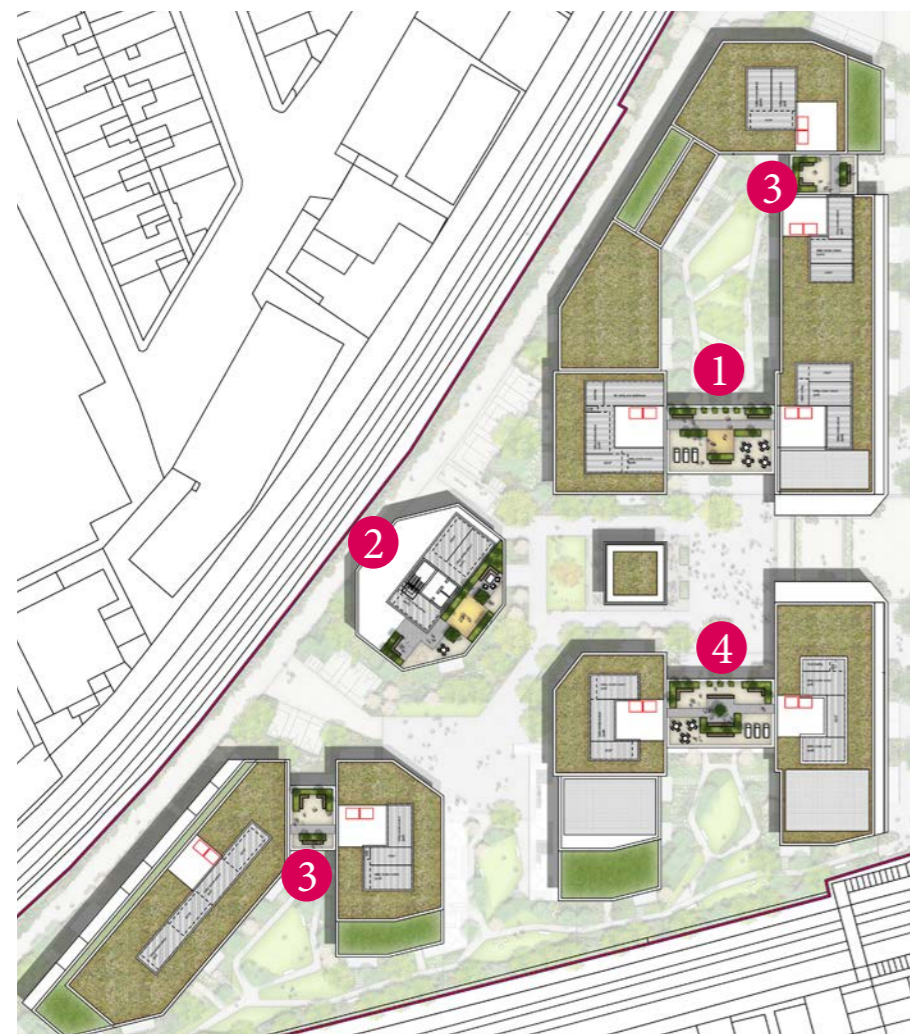

3 Block A and C communal roof terrace

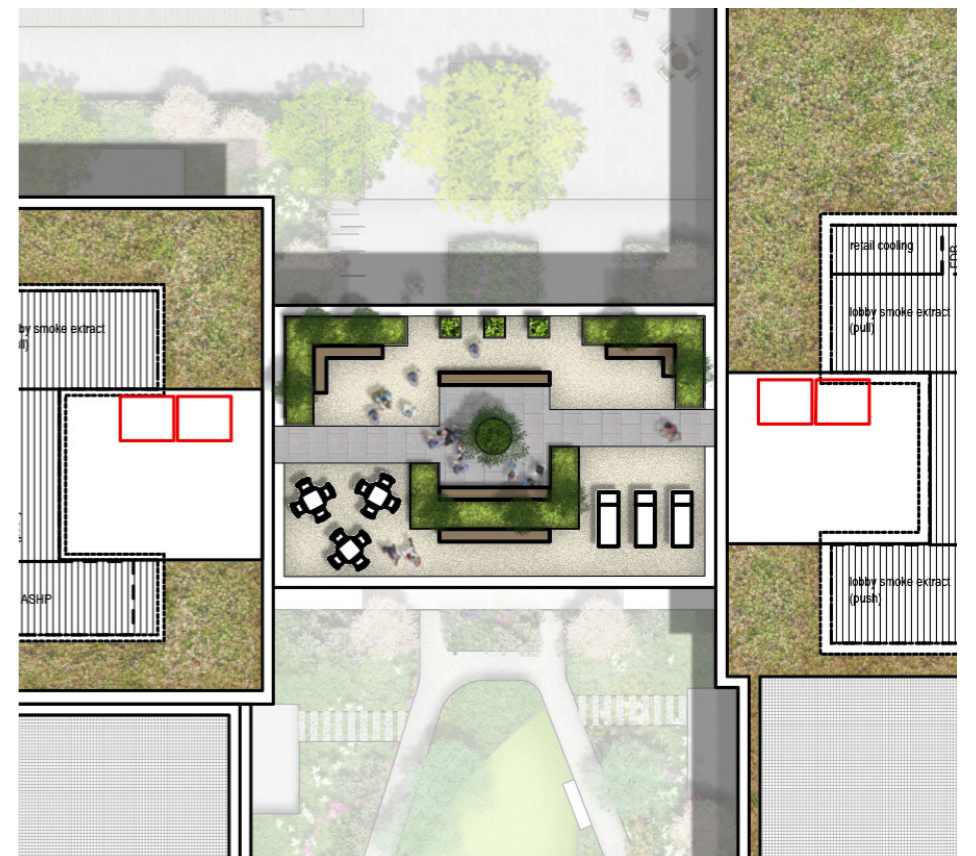

4 Block D communal roof terrace

5.36 Rain water attenuation

The drainage strategy for the site is predicated on the lack of a connection to Mains Sewer and the need to capture and infiltrate all storm water on site. (Refer Building Services section of this report)

All building roofs contain a blue roof storage capacity and two Attenuation tanks are provided in locations as shown to hold and infiltrate captured storm water. The blue roof storage extends under all other roof finishes - Living roofs, plant areas or communal terrace pavements and planting. Refer to Engineer's Preliminary Drainage Strategy Drawing.



Blue roofs and attenuation tank

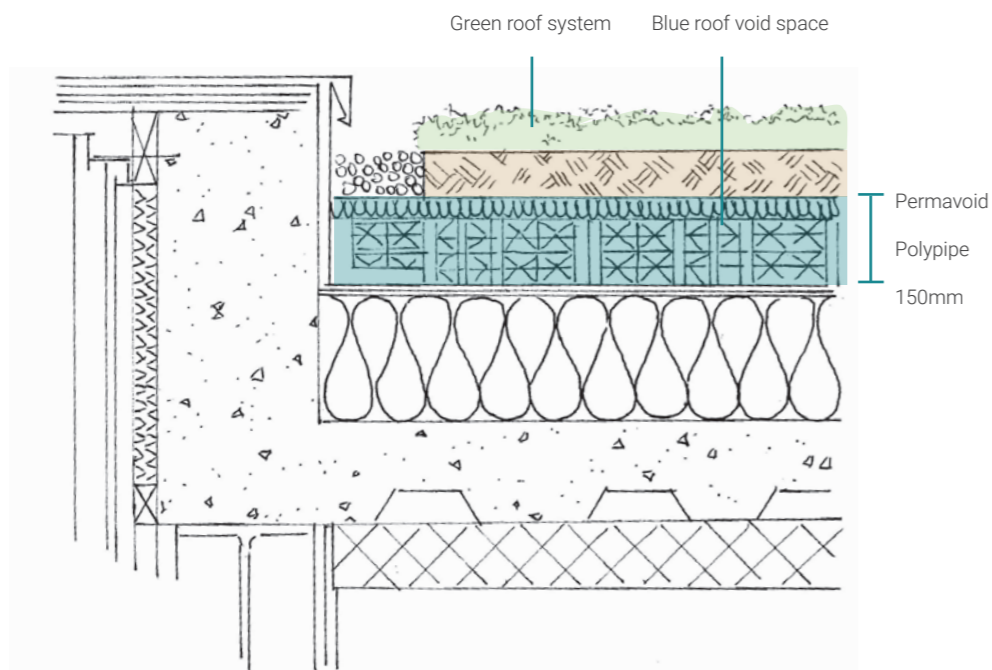

Blue roof detail

KEY

	Blue Roofs
	Attenuation tank

5.37 Existing local play provision

KEY

	Site Boundary
	Allotments
	Recreational Green Spaces
	Park/Gardens
	Multi-Sports Pitches
	Golf Courses
	Rugby Pitches
	Cricket Pitches
	Archery Pitches
	Tennis Pitches
	Pool
	Cemetery
	Woodland
	Actual Walking Distance
	Playgrounds



Google Earth

500 m

5.38 Play strategy

KEY

	0-5 Play (Doorstep)	854 m2
	5-11 Play (Local)	555 m2
	12+ Play	0 m2

Play space benchmarks used :
 0-5yrs Play (Doorstep) - 10 sqm per child
 5-11yrs Local Play - 10 sqm per child

Assessing child occupancy and play space requirements

Size of your development:

Number of FLATS

	Studio	1 bed	2 bed	3 bed	4 bed	5 bed	Total
Social rented/affordable	0	46	50	40	0	0	136
Intermediate	0	0	0	0	0	0	0
Market	0	89	110	62	0	0	261
Total	0	135	160	102	0	0	397

Number of HOUSES

	1 bed	2 bed	3 bed	4 bed	5 bed	Total
Social rented/affordable	0	0	0	0	0	0
Intermediate	0	0	0	0	0	0
Market	0	0	3	0	0	3
Total	0	0	3	0	0	3

Proportion of children

	Number of children	%
Under 5	85	49%
5 to 11	55	32%
12+	32	19%
Total	173	100%

Play space requirements

GLA benchmark (sqm)*	Alternative local benchmark (sqm)**	Total (sqm play space) required
10		853.9
10		554.4
0		0.0

* GLA benchmark standard=minimum of 10sqm of dedicated play space per child
 ** 5sqm - Borough's local benchmark

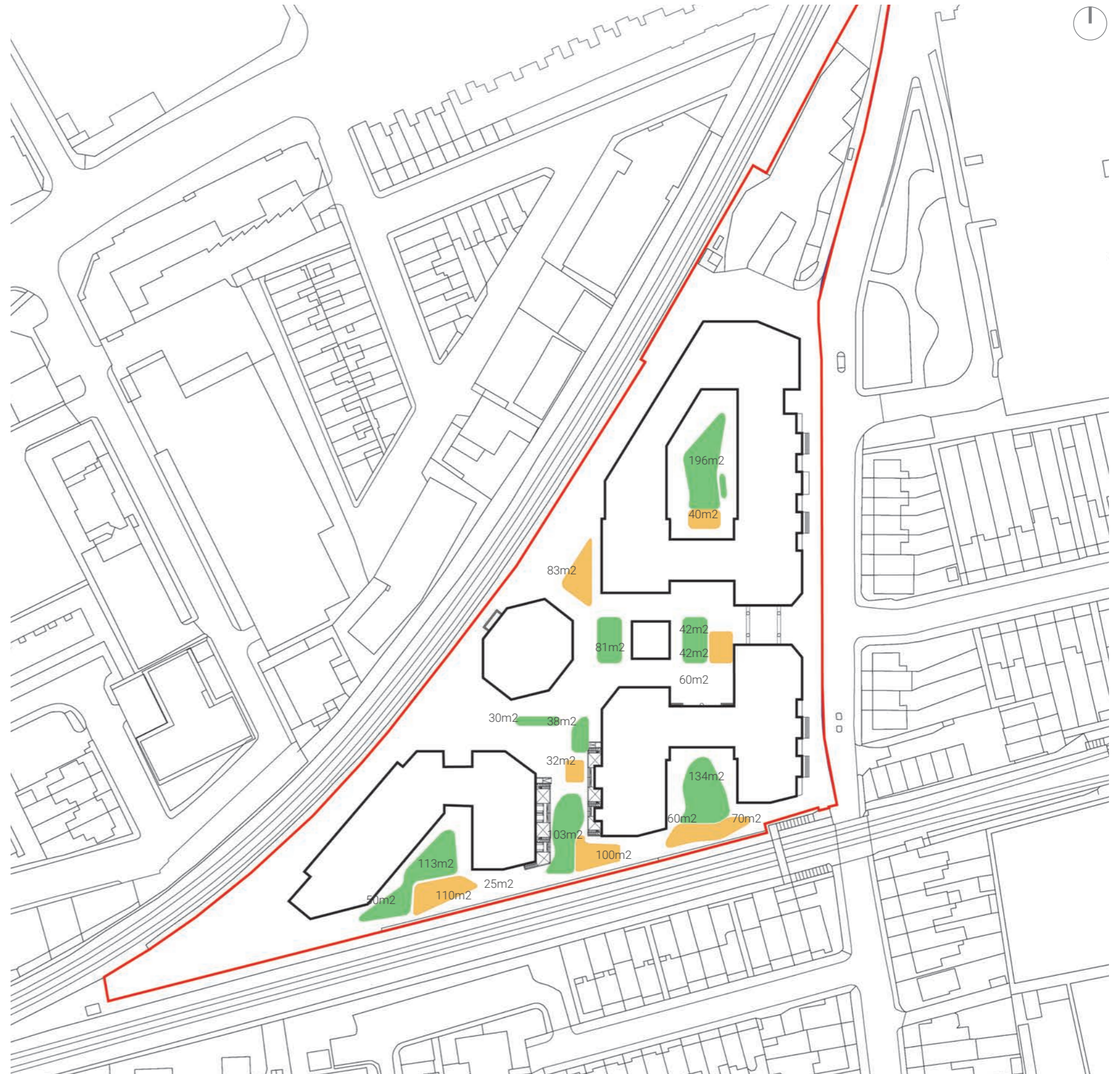

Play spaces - doorstep and local play

5.39 Play strategy - required areas

Open Space and Play

The site lies in close proximity to a number of open spaces and recreational facilities in the immediate area. Extensive open space and recreational grounds south of the canal can be readily accessed from the site and offer a variety of sporting facilities for the older children (12yrs +) from the site.

The preceding diagram indicates locations and travel distances from the site to each of these open spaces and details the facilities available at each location.

Site Play Provision:

Allocation has been made within each courtyard, including the public central space, for provision of play facilities and a playable landscape treatment incorporating a range of furniture and play elements for children aged from 0-11yrs. The designated areas (as recommended by SPG 'Shaping Neighbourhoods: Play and Informal Recreation') have been distributed across the site to suit current unit numbers and mix. (Refer diagram)

Doorstep Play:

- Required within 80M of all units front doors
- Age group (0-5 yrs)
- Climbable / balancing elements
- Playable landscapes
- Informal play in public spaces

This age group is fully catered for, at required 10 Sqm / child (854 Sqm) with on-site areas distributed through the courtyards as indicated.

Local Playable Space:

- Required within 400m of unit / site
- Age group (0-11 yrs)
- Recommended space based on child numbers (10 Sqm / child) – 555 Sqm

The design includes recommended space for this age group within the site (555 Sqm), distributed in private courtyards and common spaces, including the central public courtyard. In addition to this, some public playgrounds exist within proximity of the site as indicated on plan - at Raleigh Road (500m walk) and North Sheen Recreation Ground (550m walk) – just outside the recommended travel distances for this type of facility.

Neighbourhood Play:

- Required within 800m walk of the site
- Age Group (12 yrs +)
- Adventure playgrounds, Sport and recreation space – ball courts, pitches, MUGA fitness trails etc
- Provision recommended based on unit mix and numbers – 320 Sqm

No Neighbourhood Play Space is provided on site due to restrictions in available site area and the intent to cater for a more organised sports form of recreation for this age group, as well as casual gathering spaces and informal play activities.

Wider Context open space:

Consideration has been made of the existing available play and recreational facilities for older children (12 yrs +) in the local area and the Context Plan indicates existing facilities within the recommended travel distances for the site and the current recreational and play facilities included at each location. These facilities predominantly cater for older children (10yrs +) with organised sports and recreation (cricket, rugby, archery, golf, swimming classes etc).

It is considered that a wide range of facilities exist in the locality and these are generally accessible from the site via local streets, with proposed improvements to the existing cycle path network assisting in providing safer and easier access. Given the constrained nature of the site layout and the creation of a series of private courtyards wrapped by built form, the strategy for play is based on the following provisos and the current unit mix and numbers:

Existing facilities within the catchment of the site:

- Richmond Cricket/Archery/Tennis Clubs
- Richmond Green
- Little Green
- Old Deer Park Pool
- Richmond Athletic Association
- Richmond Rugby
- Royal Mid Surrey Golf Club
- Royal Botanic Gardens Kew
- Richmond Park

5.40 Play strategy - reference images





Introduction

Context

Design process

Design response

Landscape

6.0 Access

Appendices

6.1 Access principles

Inclusive design is about breaking down barriers and exclusion through creating places that everyone can use. It enables everyone to participate equally, confidently and independently in everyday activities. The term 'inclusive design' relates as much to the design process as to the final product and just as equally to management, operation and information, bonding user experience with professional expertise.

This section outlines the Access strategy for the proposed development on Manor Road, Richmond. It supports the drawings prepared for this planning scheme. The aim is to provide a clear description of how the users of the proposed development will access, and be guided through the building and the site, without discrimination or limitation. This Access section deals with the design, up to planning, and the aspirations of the design for its development and final realisation through the construction process.

39 (10%) of the residential apartments identified as wheelchair Part M4(3) units. Wheelchair apartments have been chosen at various floor levels throughout the development, accessible via two lifts, and provide a balanced mix of unit sizes and tenure. These apartments are designed specifically for ease of use for visually impaired, ambulant disabled and wheelchair bound residents.

6.2 Legislation, standards and guidance

Policies, legislation and guidance followed in the preparation of the Access Statement include:

- London Legacy Development Corporation planning policies on inclusive design and access and relevant housing policies
- Building Regulations: Approved Documents M 2015 and K 2013 (hereafter referred to as AD M and AD K)
- Technical Housing Standards- Nationally Described Space Standard March 2015
- Mayor of London Plan 2016
- BS 8300: 2009 + A1:2010
- Building Regulation Part B/BS 9999:2017
- The Human Rights Act 1998
- Equality Act 2010



6.3 Masterplan access principles

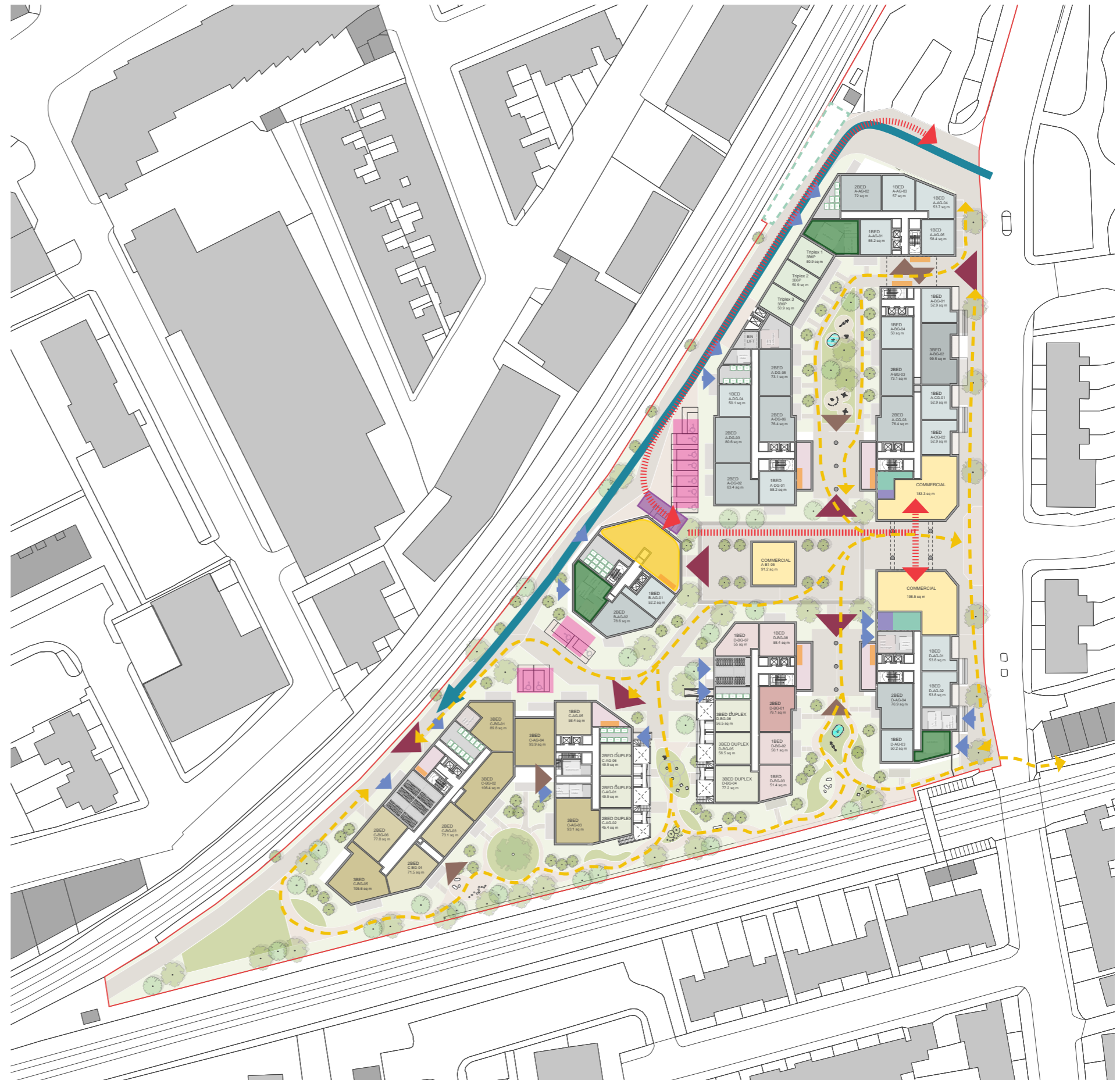

- Key:
- Central concierge location
 - Post box locations
 - New public realm
 - Communal entrance
 - Access to courtyards
 - Non residential entrances
 - Pedestrian routes
 - Main access for general waste truck
 - Residential refuse store
 - Retail refuse store
 - Temporary refuse collection points
 - Substation/Gas meter room
 - Retail unit deliveries
 - Loading bay
 - Disabled parking bays

6.4 Access philosophy

6.4.1 Introduction

The development is easily accessible by foot, cycle, public transport and car.

Pedestrian approach:

The site is located on Manor Road, Richmond upon Thames.

Principle residential entrances, located at the bases of buildings A, B, C and D provide access to the development from the new public realm.

From here all building cores can be accessed. Entrances to the townhouses and duplex units are via the western access road or from the public realm.

The proposals include residents' cycle and refuse stores, located adjacent to cores.

Public transport:

The closest train station to the site is North Sheen, which is located 150m to the south-east of the site where destinations such as Richmond, Chiswick, Wimbledon and London Waterloo can be reached directly.

The nearest bus stop is located on Manor Road (circa. 1 minute walk) which provides frequent services to Richmond town centre, Kingston, Twickenham, Barnes, Chiswick and Kew.

The site has a PTAL rating of 5.

Vehicular and cycle access:

The site will have surface parking along the access road, to the western site boundary. 12 wheelchair accessible parking spaces, alongside 2 car-club spaces, have been provided across the development with space allocated for an additional 19 spaces if required. These spaces have a 1200mm clear access zone to at least one side of the parking space. The parking spaces are level with a suitable ground surface.

A loading bay is provided adjacent to the concierge at the base of Building B. Servicing for the commercial units will happen from within the site boundary to alleviate pressure on the already congested Manor Road. Deliveries to the commercial units will need to be wheeled across the public square from the loading bay.

Vehicular access to this will be provided from Manor Road using the existing site entrance.

Secure internal cycle parking will be provided adjacent to entrance lobbies in blocks C and D and within a basement cycle store below block A. A small amount external cycle parking will also be provided within the public realm for visitors and for the commercial units.

Public Realm:

The public realm will be accessible to all as part of an inclusive design philosophy. Users with disabilities are not segregated and are able to move through the public realm and the buildings. They will use the same entrance, corridors and rooms as everyone else without detour.

Residential Access:

Where possible ground floor flats will have front door access from the street and new public realm to maximise activity at ground floor and to help animate the street. Every ground floor unit has dedicated defensible space to aid privacy and provide a buffer. To increase privacy to ground floor units most are raised off the ground and accessed via a couple of steps. In these instances level access is provided to the communal corridor via the back of the flat.

The entrances to all buildings and apartments have been designed and located in such a manner as to make them obvious and easily accessible from the public realm. This is the same for disabled access. All shared residential lobbies and entrances are large spaces with secure post boxes and are located in prominent positions on plan.

All entrances are designed to provide level access from the public realm, as required by Part M, with a clear open space in front of the doors. This accessible approach leads to a level entry threshold and to the internal lobby. A slip resistant material for this walkway will be provided. The routes to the entrance, from the public footpath, will be well lit.

A similar approach is applied to the entrances of all no residential uses. Access to the elevated terrace spaces is via apartment cores. Access to the play spaces and communal gardens is via well designed and overlooked paths to help forge a legible and secure environment for residents.

Concierge:

A 24hr concierge will be present in the base of Building B within the main entrance lobby. The position on site allows surveillance of the surrounding buildings and new public square.

Post will be delivered to individual post boxes located on the ground floor of each core entrance. Larger packages will be delivered to the concierge and stored accordingly.

External landscaping:

A series of amenity spaces are provided throughout the scheme, some with public access, some semi-private and some for residents only. The terraces of the link blocks at the upper levels will be landscaped as amenity space for residents to enjoy, offering more privacy and security than at ground level.

The hard and soft landscape design is based on a strategy to ensure ease of long-term maintenance and management. Practical considerations will include the use of durable, non-slip hard landscape materials, benefitting not only disabled, but older people and children too.

The provision of direct routes between well-used locations, regular placement of seating and resting points along paths, the use of quality tactile and textured surfaces, contrasting colours, appropriate lighting and signage will be utilised to aid navigation around the site. Visual clutter and obstructions will be minimised, where possible.

See Landscape and public realm section of this document for all details regarding hard and soft landscaping materials and design.

Surface materials:

The entire public realm will be accessible, with the pavement textures selected in order to balance the needs of wheelchair users (who require a low resistant surface) with the needs of crutch and stick users (who require more purchase during wet weather).

The key principles for the palette of considered surface materials will include the following:

- A visual contrast in colour between the pedestrian and vehicular access
- Tactile paving defining pedestrian and vehicular areas
- Surfacing designed to aid way-finding

Surface textures:

Manual wheelchairs require smoother surfaces to move across. The more tactile the surface, the harder it is for the user. Counter to this is the need for ambulant disabled people to gain some purchase for their sticks or crutches.

Where footpaths and road surfaces are flush, careful consideration of the transition between the two needs to take place. Flush transitions cause guide dogs difficulty in sensing the change in condition.

One proposal is a change in pavement colour mix, used to give the appearance of a level surface whilst defining the public and private realm.

Width/gradient to footways:

Pedestrian routes will follow desire lines as much as possible; footpaths will be of a suitable width as to allow users at all mobility levels to pass comfortably, including wheelchair users and adults with children. Street furniture such as directional signs, lighting and seating will be located just off the perimeter of the access routes to minimise obstructions. All signage will be colour contrasted.

Where required, ramps have been used in favour of steps when changes in level are required, avoiding segregation of users with disabilities and allowing access for wheeled vehicles. All external ramps within the public realm are of a gradient no steeper than 1:20.

Landings will be provided along all long lengths of steps or ramps to allow resting points. Hand rails are provided to all ramps and steps where required to provide support and guidance. They will be colour-contrasted to make them easily visible, easy and comfortable to grip and they will have no sharp or protruding edges and will be located at the correct height (900mm) and will extend for 300mm.

Cross falls to footpaths:

Cross falls are important on footpaths to move standing water to the edges, stopping ice from forming on cold days. The need for this surface drainage must be balanced with the difficulty a manual operated wheelchair has moving across a cross fall. The design of the footpaths around the site have minimal cross fall to balance both needs.

External street lighting & CCTV:

A balanced level of lighting has been considered. This will be designed to avoid strong contrasting pools of light and silhouette. The lighting design supplied will be of a safe and comfortable illumination level, assisting access and improving security.

Routes across the site will be lit in accordance with BS 5489 and CIBSE Standards, subject to planning. The spread of light will be even and the lamp type chosen will provide a light with good colour rendering properties. Timing controls will be introduced to allow the switching off of certain parts of the lighting at key times to save energy and discourage use at night close to residential areas. Key entrances to the buildings, will remain illuminated.

All open spaces such as the podium and other accessible areas within the development will be illuminated at both high and low levels at the appropriate lux figure for their contextual setting.

Please refer to the Lighting design masterplan and report, which has been prepared by Hoare Lea.

Plant and Utilities:

The majority of the plant will be located on the roof tops, and will be accessible via a roof hatch. High parapets or balustrades will provide protection during maintenance of this plant. Plant replacement will be via the roof hatch and cores.

Additional plant rooms are located on the ground floor and within a basement, the majority of these are accessed along the service road along the western site boundary. Lifts from the basement are also located along this access road.

Refuse:

Bin stores for each block are located adjacent to cores and within 30m of flats as per Approved Document H. For private apartments there will be a managed refuse solution on site and refuse will be moved and stored within a central refuse store in the basement below block A. A refuse holding area is located along the access road near the vehicular entrance to the site.

Access for refuse vehicles is via the access road to the western site boundary. Refuse stores and holding areas are located not more than 15m from the collection points.

Appropriate space has been allocated for waste and recycling within properties.

Please refer to the Waste management strategy, which has been prepared by Momentum.

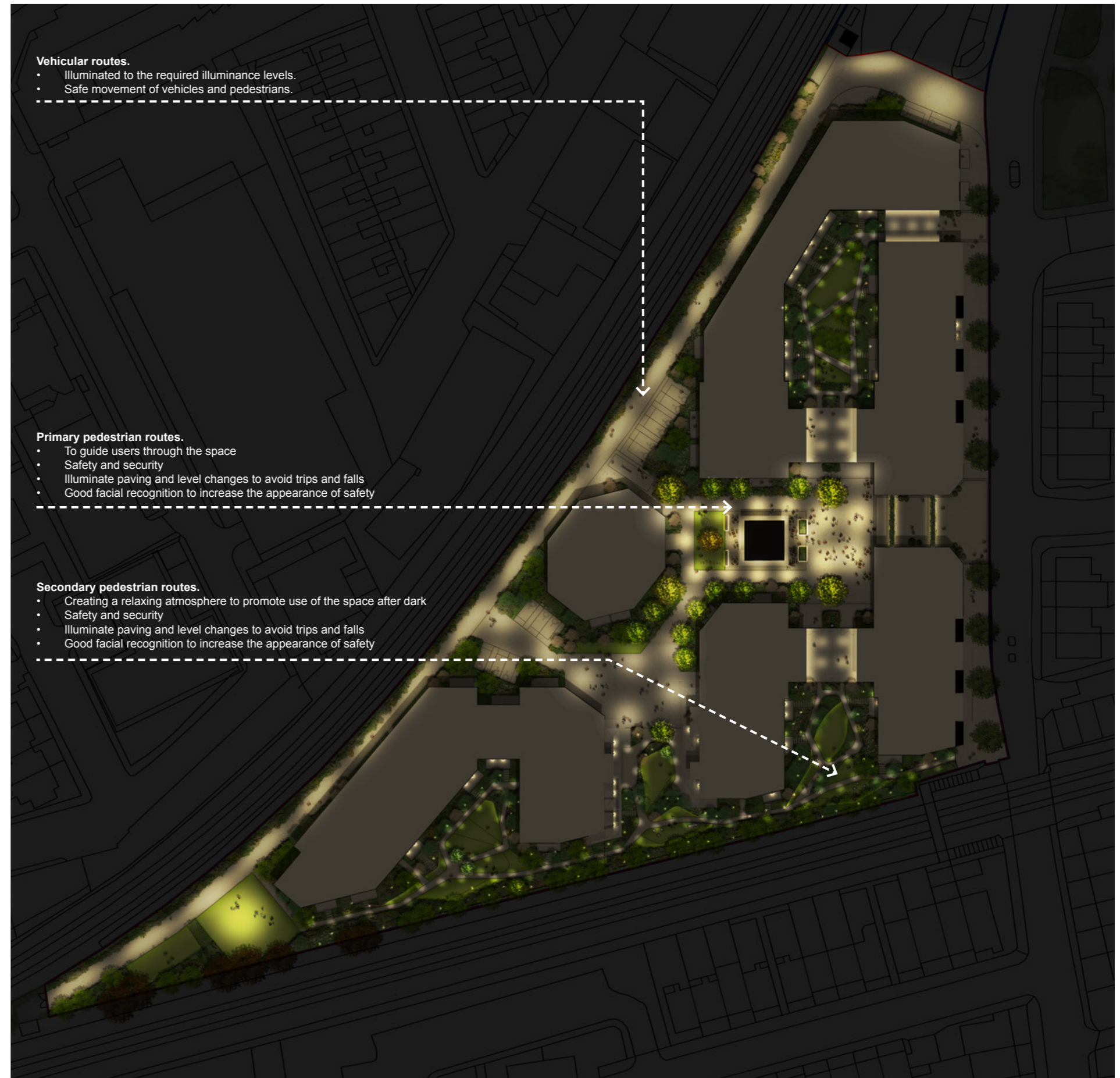

External lighting strategy for main part of site. Image from Hoare Lea's external lighting report.

6.5 Building environment

The buildings are set within a hard landscaped environment at street level. There are level changes across the site where ground floor units have been raised 900mm above ground. This will be accommodated at street level by steps up to front doors of ground floor units and the use of ramps of very shallow gradients integrated into the landscape design. A level threshold is provided to all commercial units.

Level access is provided to all residential apartments and each building has its own private entrance with level access from the street. Roof level external amenity space is provided, which is only accessible by residents.

6.6 Building and structures

Materials

The proposed materials have been specified (using Part M specifications) to contrast tonally with the ground finishes, enabling people with visual impairments to identify building boundaries.

Construction

The design follows a simple concept based on the clarity of the overall structure of the building. Slab levels have been set to ensure that the structure will not impose restraints upon individuals using and moving through the building, including ensuring obstructions are avoided in pedestrian/common areas and that level access can be provided throughout.

Internal floor surfaces

The floor finishes will contrast tonally with the walls and will be of a non-slip. Finishes will be contrasting in the vertical and horizontal situations. Floor surfaces will not be overly resistant to wheelchair users, but will aid crutch users in gaining purchase. As well as this, floor finishes will be of a robust and durable nature.

Entrances

Each building provides a correct transition from outer spaces to inner spaces to all users. The approach to the buildings will be well lit and obvious.

Transition to internal

The entrances will have manifestation to identify them, and the frames will be of a strong tone or colour to visually separate them from the surroundings. Entrances will be appropriately lit. The main entrance doors are designed to comply with relevant legislation in terms of minimum width opening and closing and the thresholds will be level.

Opening windows and projections on public routes

Obstructions at head height can be dangerous to the visually impaired. All opening windows and projections have been minimised within the design. Where they can't be removed completely, vegetation has been provided at ground floor to notify people of the potential for window opening. Where possible, outward swinging doors are avoided and, where required due to fire escapes, they will be marked by blistering, vegetation or bollards.

Steps and ramps

All steps, stairs and ramps have been designed to comply with Approved Document Part M 2015 and BS 8300:2009. This includes tread, risers, handrails, lighting and nosings.

Door design

All doors of the scheme, both manually operated or automated, are compliant with Approved Document Part M 2015 and BS 8300:2009 according to different uses and users of the buildings, specifically in relation to vision panels, weight, colour, door ironmongery and use of materials.

To meet the requirements of Approved Document Part M, door closer tensions will be set to a maximum of 20N. The clear opening widths of all doors in common areas are a minimum of 850mm and there will always be 300mm nib on the leading edge of a door.

Movement within buildings

This key subsection relates to the internal circulation within each building, considering specific needs of disabled people.

The buildings are accessed via horizontal corridors. Vertical circulation is via lifts in the cores, and ambulant disabled stairs.

Provision of lifts:

All lifts, in all buildings, are designed to comply with Approved Document Part M and BS 8300:2009, including size, internal materials, door opening width, and operating apparatus.

Stairs:

Stairs comply with Approved Document Part M and BS 8300:2009 in terms of widths, treads, risers, hand rails, nosings, top and bottom surfaces, landings and finishes.

They have also been designed for ambulant disabled, including the fire escape stairs.

Corridor and lobby design:

All corridors within the buildings comply according with their specific uses and with Approved Document Part M in terms of size, lighting, materials, signings, doors and colours etc.

There are no changes in level to any corridors and width is consistent. Vision panels in corridor doors will be designed to allow people both seated or standing to be seen.

Pull handles will only be fitted on the pull side of doors and fingerplates will be fitted on the push side. This assists all users, but especially people with learning difficulties and people with visual impairments. Handles will not extend down to floor level since this type of handle can become caught in the footplates or wheels of a wheelchair.

There is adequate space between lobby doors for a wheelchair user to clear one door before opening the next.

6.7 Means of escape

Design for independent means of escape

All features and materials comply with Approved Document Part B (2013). In addition, a management plan will be prepared for the evacuation of the buildings together with the preparation of a Personal Egress Emergency Plan.

With residential buildings, it is encouraged that, in the case of fire, inhabitants stay in their apartments. Each apartment has a 60 minute fire rated compartment surrounding it, to ensure that residents are protected from the source of the fire.

Facilities for physical evacuation

The escape routes, horizontal and vertical, meet the minimum widths to comply with ambulant disabled requirements. Escape stairs meet ambulant disabled goings and risings. Disabled refuge provision is made, where required. At upper residential levels no refuge has been allowed for, as the fire strategy is for people to remain in their apartments while the fire brigade deal with the fire.

Together with the Fire Alarm System, and the Personal Egress Emergency Plan, the buildings are designed to provide, according with their different uses, safe evacuation routes in the case of emergencies.

Please refer to the Executive Fire Strategy Summary, which has been prepared by Hoare Lea.

6.8 Signs and way finding

External signage

The signage strategy for the development will follow good practice guidelines, such as the "Sign Design Guide". All signage will be contrasting and designed for those with learning difficulties or visual impairments.

Internal signage

All the buildings according to their uses are designed to enable clear signposting and a messaging system complying with the Sign Design Society Guidance.

All internal signs to communal areas will be clear, with contrasting symbols, and with braille translations to help the visually impaired. All signage will be located in obvious locations and will be well lit.

The use of differing tactile materials

A palette of tactile handrails/support rails showing directions of travel to the nearest fire exit have been considered through the design of each building.

The layout of the buildings

The clear layout of the building, generally arranged with a sequence of entrance/lobby/lift/stair core/corridors, allows a simple circulation throughout and between the floors. A readable structure and shape provides an easy indication to distinguish different uses within the site.

6.9 Secure by Design

The scheme has been designed to encourage passive surveillance from surrounding residential buildings to overlook entrances and pedestrian routes within the site.

Through discussions with the local Design Out Crime Officer the scheme has evolved to allow for the following:

- Limit number of units accessed from cores
- Central concierge position to provide surveillance to the new areas of public realm
- Residents courtyards to have fob access gates
- Bins to have secondary locking door
- Bikes to have one opening door
- Lighting design will be sensitive to wayfinding and antisocial behaviour and switched off to discourage rough sleeping.
- Allow for retrofitting of CCTV to lampposts

All design will be carried out with the Secured By Design New Homes 2010 design guide in mind.

Discussions also covered the south-western tip of the site which was highlighted as an area which may be susceptible to anti-social behaviour. This area of the site benefits from passive surveillance from apartments in block C and can only be accessed by the public via public realm adjacent to the concierge office. Additional external lighting has been included in this area to provide an added level of security.

6.10 Accessible & adaptable dwellings

The location of the wheelchair user dwellings have not yet been defined. However the oversized units on the scheme would typically be allocated as wheelchair user dwellings.

90% of the units across the site will be M4(2) wheelchair accessible and adaptable dwellings the remaining 10% meet M4(3) criteria for wheelchair user dwellings.

The units highlighted in pink on the adjacent typical plan show the over-sized units and potential wheelchair adaptable and accessible dwellings.

6.11 Accessible and Adaptable Dwellings- Part M4(2) compliance

The following section demonstrates compliance with the criteria set out by M4(2). Listed below are the criteria for compliance with Part M4(2) which is followed by supporting annotated drawings.

M4 (2) Section 2A: Approach to the Dwelling

6.11.1 Approach Routes

General

The approach route to all dwellings is level with some ground floor units benefitting from an additional private entrance via a series of external steps. Communal parts of the approach route (except communal stairs) have a minimum clear width of 1200mm. All parts of the external approach routes will have a suitable ground surface.

External and internal ramps forming part of an approach route
All ramps comply with diagram 2.1, have a top and bottom landing of the minimum width required and have a clear width of at least 1200mm.

6.10.1 Car parking and drop-off

Parking space

Parking spaces are located along the access road to the back (western edge) of the site. Each parking space has a clear access zone of 1200mm to one side.

Drop-off point

The drop off point is close to the principle communal entrance in building D and is level with a suitable ground surface.

6.10.2 Communal Entrance

Principal Communal Entrances

The principle communal entrance has a level landing 1500mm x 1500mm directly outside and clear of any door swing. This will be covered to a minimum of 1200mm width and 900mm depth. Lighting will use fully diffused luminaires that are activated automatically by a dusk to dawn timer or a motion detector. The entrance door (including double doors) has a minimum clear opening width of 850mm, and a 300mm nib is provided to the leading edge of the door, in accordance with diagram 2.2. Door entry controls will be mounted 900-1000mm above finished ground level, and at least 300mm away from any projecting corner.

Other communal doors

All other communal doors have a minimum clear opening width of 850mm, and a 300mm nib will be provided to the leading edge of the door, in accordance with diagram 2.2. Door entry controls will be mounted 900-1000mm above finished ground level, and at least 300mm away from any projecting corner.

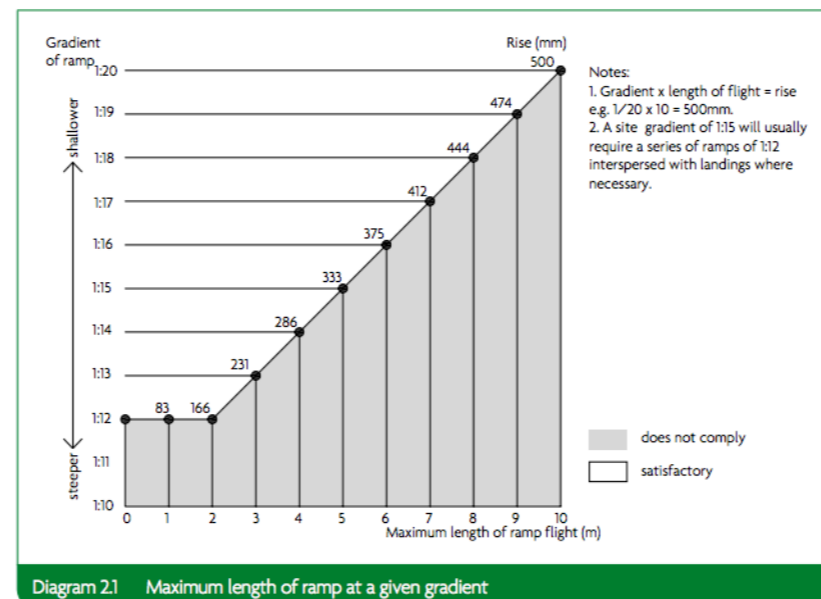

Diagram 2.1 Maximum length of ramp at a given gradient

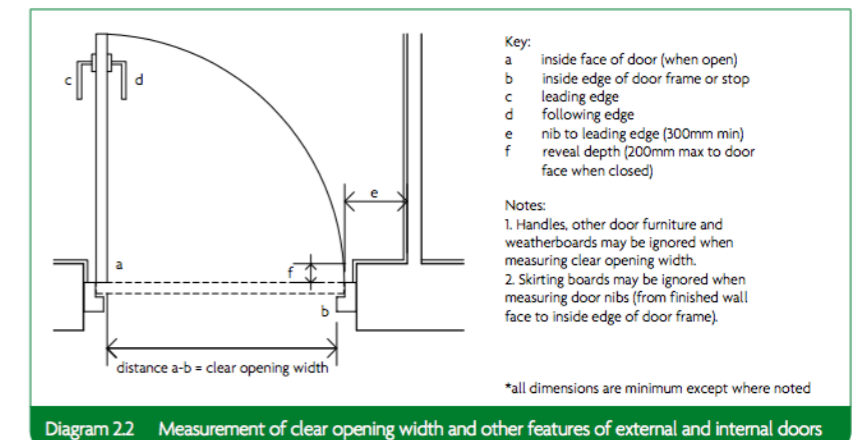

Diagram 2.2 Measurement of clear opening width and other features of external and internal doors

6.10.3 Communal Lifts and Stairs

Communal lifts

2no. 13 person lifts (of which 1no. is a fire fighting lift) with a car size of 1600mm wide and 1400mm deep inside are provided to buildings B, C, D and E, and 2no. lifts are provided to building A. Each lift has a clear landing of 1,500mm x 1,500mm directly in front of the lift door at every floor level, a door clear opening width of at least 800mm and meet BS EN 81-70:2003. Landing and car controls will be 900-1200mm above the car floor and a minimum of 400mm from the inside of the front wall.

Communal stairs

Each building is served by 1 communal stair core which meets the requirements of Approved Document Part K for a general access stair. Additional escape stairs are provided from the podium amenity levels, which will also meet the requirements of Approved Document Part K.

6.10.4 Private entrances

Principal private entrance and alternative entrance

The principle private entrance to each apartment will have a level landing 1200mm x 1200mm directly outside. This will be covered to a minimum of 900mm width and 600mm depth. Lighting will use fully diffused luminaires that are activated automatically by a dusk to dawn timer or a motion detector. The entrance door (including double doors) has a minimum clear opening width of 850mm, and a 300mm nib is provided to the leading edge of the door, in accordance with diagram 2.2.

Other external doors

All other doors connected to the dwelling will have a minimum clear opening width of 850mm, and a 300mm nib is provided to the leading edge of the door, in accordance with diagram 2.2.

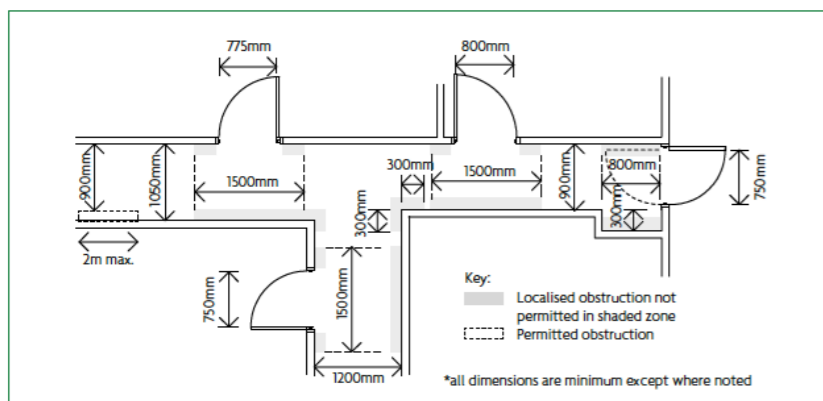

Diagram 23 Minimum door and hall widths and restrictions on localised obstructions

6.11.2 Circulation areas and Doorways

Door and hall widths

The minimum clear width of every hall or landing is 900mm. Localised obstructions will not occur opposite or close to a doorway and the corridor will not be reduced below 750mm width at any point. The clear opening widths will conform to those set by Approved Document M and a 300mm nib will be provided to the leading edge of every door within the entrance storey.

Private stairs and changes of level within the dwelling

Access to all rooms and facilities within the entrance storey will be step-free, with no level changes. The stair from the entrance storey to the storey above will have a minimum clear width of 850mm when measured above the pitch line of the treads. All stairs meet the provisions of Part K for private stairs.

6.11.3 Habitable rooms

Living, kitchen and eating areas

Within the entrance storey of all units there is a living area. A minimum of 1200mm clear space is provided in front and between all kitchen units and appliances.

Bedrooms

Every bedroom has a clear access route, minimum of 750mm wide from the doorway to the window, and at least one double bedroom will provide a clear access zone a minimum of 750mm wide to both sides and the foot of the bed. Other double bedrooms have a clear access zone a minimum of 750mm wide to one side and the foot of the bed.

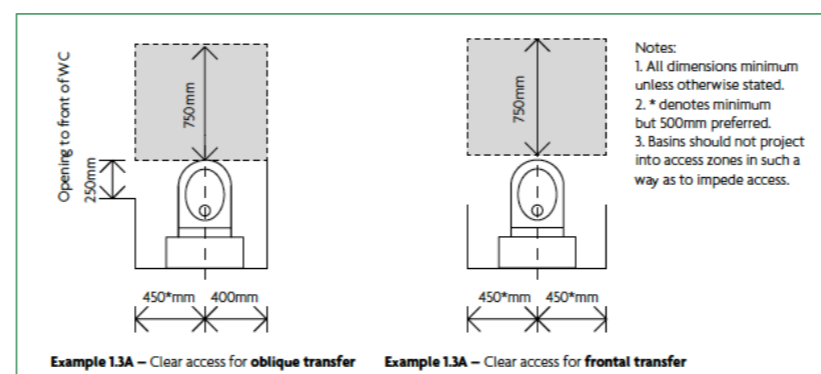

Diagram 13 WC access zones

6.11.4 Sanitary facilities

General provisions

All walls, ducts and boxing to the WC/Cloakroom, bathroom and shower rooms will be strong enough to support adaptations that could impose a load of up to 1.5N/m².

WC facilities on the entrance storey

Every dwelling will have a room that provides a WC and basin on the entrance storey. In two storey dwellings, with one or two bedrooms, the WC meets the provisions of diagram 1.3 and the basin does not impede access to the WC.

In two storey dwellings with three bedrooms, the room with the WC and basin provides a potential level access shower.

The door to the WC will open outwards.

Bathrooms

Every dwelling has a bathroom that contains a WC, a basin and a bath, that is located on the same floor as the double bedroom described as the principle bedroom above.

6.11.5 Services and controls

Consumer units will be mounted so that the switches are between 1350mm and 1450mm above floor level. Switches, sockets and controls will have their centre line between 450mm and 1200mm above floor level and a minimum of 300mm from an inside corner.

The handle to at least one window in the principle living area is located between 450mm and 1200mm, or a remote opening device will be fitted. Handles to other windows will be located between 450mm and 1400mm above floor level, or a remote opening device will be fitted.

Boiler controller will be mounted in an accessible location between 900mm - 1200mm above finished floor level.

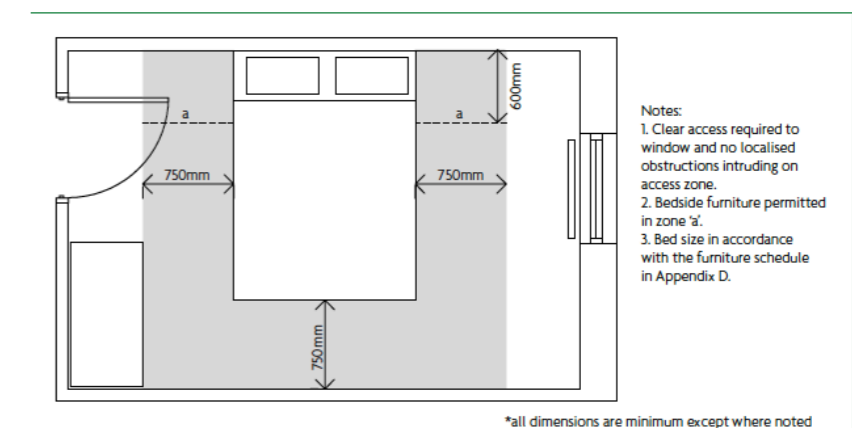
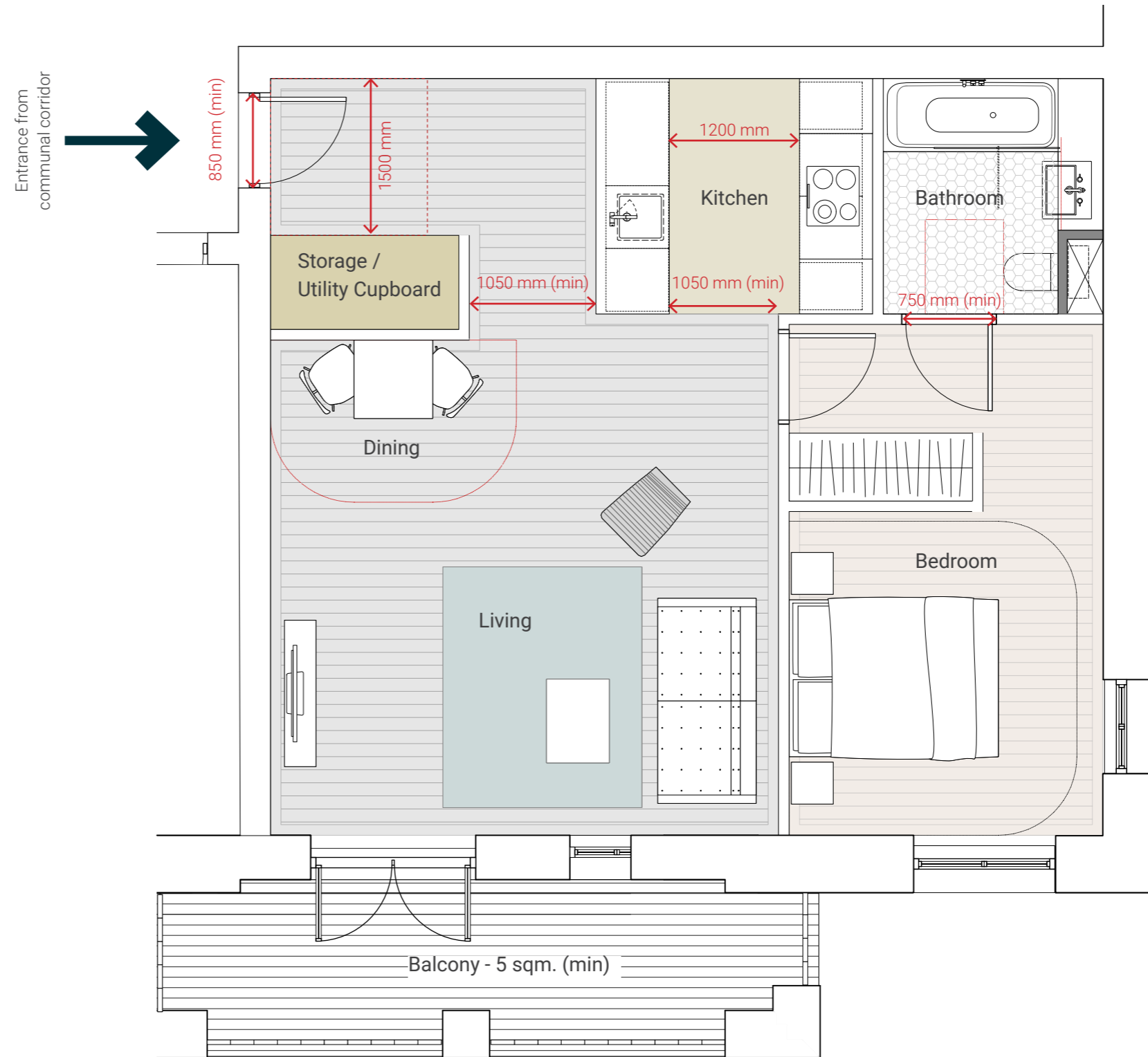
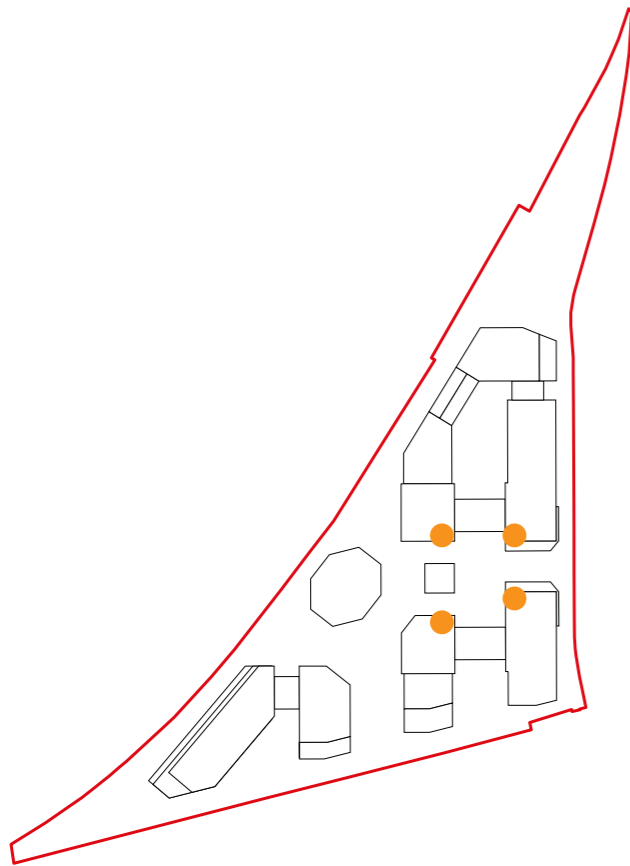

Diagram 24 Clear access zones to principal bedroom

6.12 Typical M4(2) flat layouts

6.12.1 Typical M4(2) 1 bedroom flat

- Dual aspect
- Generous window provision
- Private amenity space off the living room
- Entrance lobby minimum of 1500mm wide
- Standard corridor width of 1050mm
- Minimum living room width of 3.6m



1 bedroom M4(2) apartment. Scale 1:50 @ A3

6.12.2 Typical M4(2) 2 bedroom flat

- Generous window provision
- Private amenity space off the living room
- Ample storage and generous wardrobe space
- 2 bathrooms
- Entrance lobby minimum of 1500mm wide
- Standard corridor width of 1050mm
- Minimum living room width of 4.2m

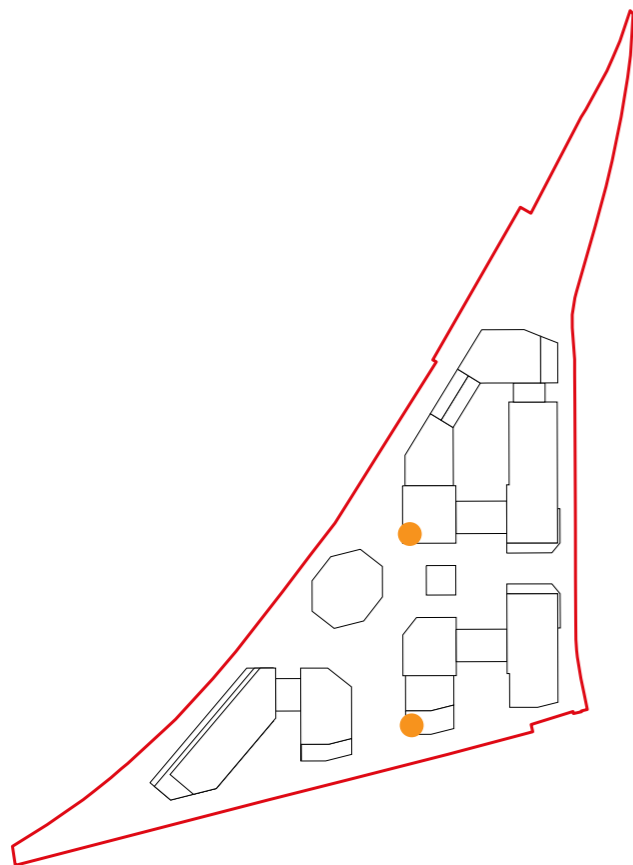
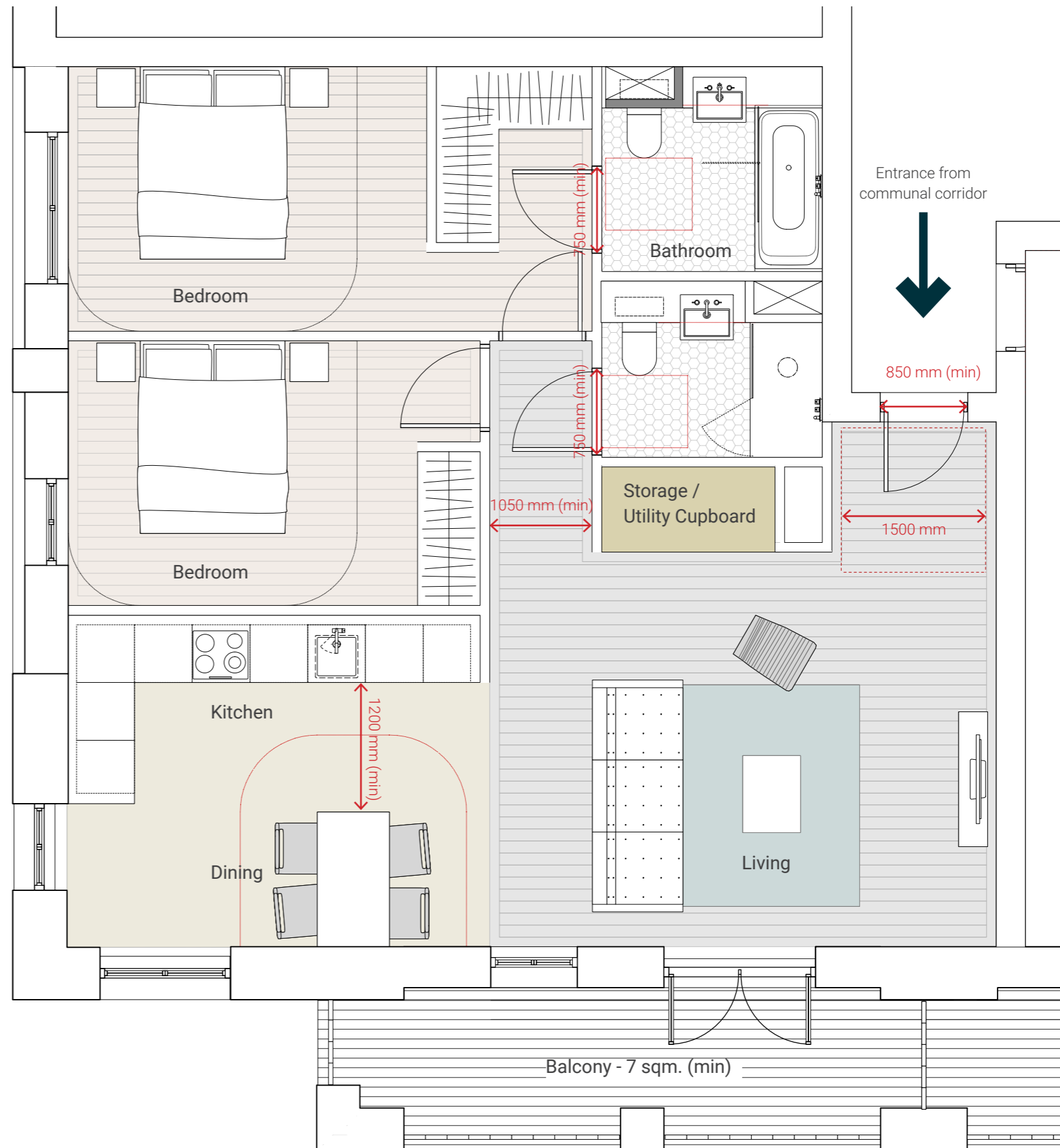

2 bedroom M4(2) apartment. Scale 1:50 @ A3

6.12.3 Typical M4(2) 3 bedroom flat

- Dual aspect
- Generous window provision
- Private amenity space off the living room
- Ample storage and generous wardrobe space
- 2 bathrooms
- Entrance lobby minimum of 1500mm wide
- Standard corridor width of 1050mm
- Minimum living room width of 4.5m

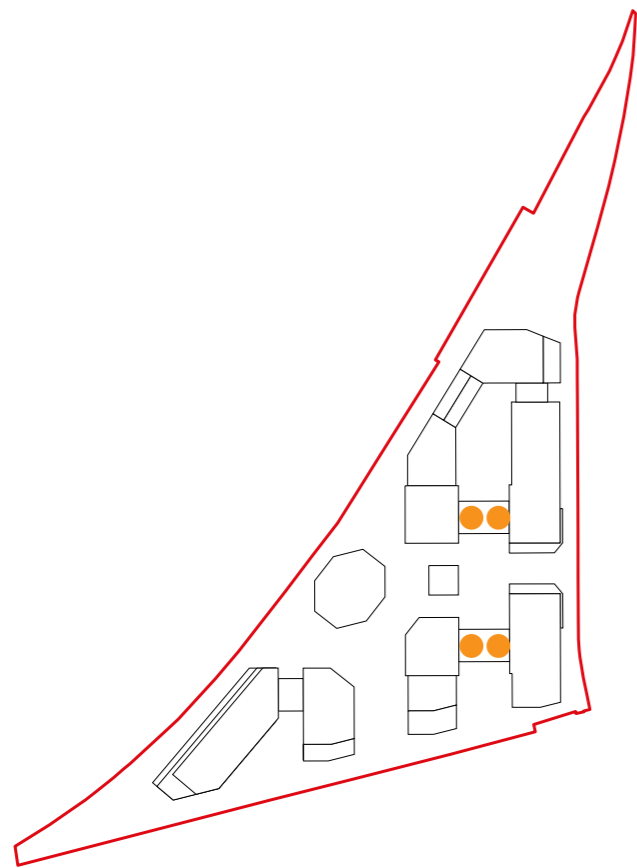

Entrance from communal corridor

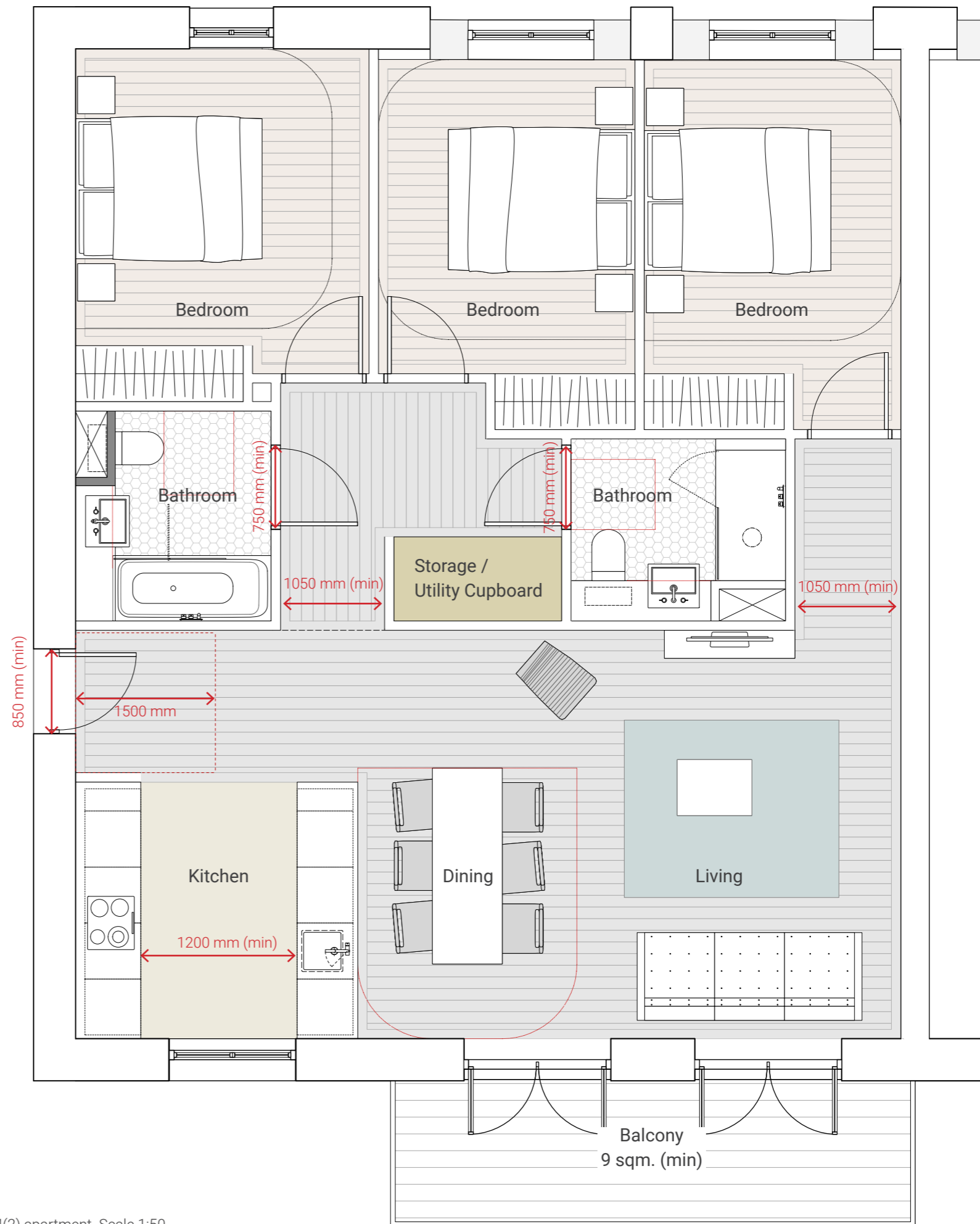

3 bedroom M4(2) apartment. Scale 1:50

6.13 Part M4 (3) 'Wheelchair user dwellings'

To be read in conjunction with individual unit type plans.

10% of the residential dwellings will comply with Approved Document Part M4(3) of the Building Regulations., in line with RBRuT policy:

10% of all private for sale units in the development to comply with Building Regulations requirement M4(3)(2)(a) 'wheelchair adaptable dwellings'.

10% of all social rented units in the development to comply with Building Regulations requirement M4(3)(2)(b) 'wheelchair user dwellings'.

The following section covers the specific requirements of M4(3).

Storage

Each wheelchair dwelling layout provides a wheelchair storage (1,100mm x 1,700mm) and transfer space with a clear width of at least 1,200mm.

Storage is provided in accordance with the minimum areas given.

No wheelchair dwellings are multi-storey and as such no provision is required for a through-floor lifting device.

Living, kitchen and eating area

All apartments are single storey therefore the principal living area is on the entrance storey and the minimum internal floor area of the living room, dining room and kitchen meets the figures in table 3.2. The glazing system features a transom that is no higher than 850mm above floor level.

Each wheelchair dwelling features an open plan living, dining and kitchen arrangement and the kitchen has a clear access zone of 1,500mm in front and between all unit and appliances.

The (adaptable) dwellings have worktop runs in accordance with table 3.3 and the layouts demonstrate how the kitchen could be easily adapted to meet the provisions of wheelchair accessible requirements at a future date without significant structural alterations or impact upon the rest of the dwelling.

The accessible dwellings have the full run of worktops required, as stated in table 3.4. The worktop incorporates a 2200 mm minimum continuous section which includes a combined sink, drainer unit and hob. This section is either a height adjustable worktop or a fixed section capable of being fixed at various heights as required.

Bedrooms

Every bedroom provides a 1000mm wide clear access route from the doorway to the window. Every bedroom has a 1,200mm x 1,200mm manoeuvring space inside the doorway but clear of the bed and closed door. The principal double bedroom has a minimum floor area of at least 13.5 sq. m and a minimum width of at least 3m. The principal bedroom also has a clear access zone 1,000mm wide to both sides and the foot of the bed and 1,200mm x 1,200mm manoeuvring spaces on both sides of the bed.

Every other double bedroom has a minimum floor area of at least 12.5 sq. m, a minimum width of 3m and a 1,000mm clearance zone to one side of the bed and in front of all furniture. Every other single bedroom has a minimum floor area of at least 8.5 sq. m, a minimum width of 2.4m and a 1,000mm clearance zone to one side of the bed and in front of all furniture.

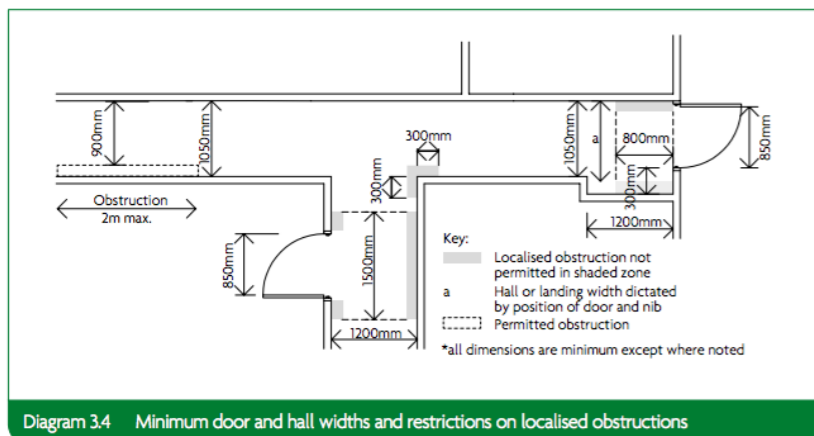

Diagram 3.4 Minimum door and hall widths and restrictions on localised obstructions

Number of bedspaces	2	3	4	5	6	7	8
Minimum floor area m ²	25	27	29	31	33	35	37

Number of bedspaces	2	3 & 4	5	6-8
Minimum worktop length (mm)	4330	4730	5630	6730

Number of bedspaces	2	3 & 4	5	6-8
Minimum worktop length (mm)	6130	6530	7430	8530

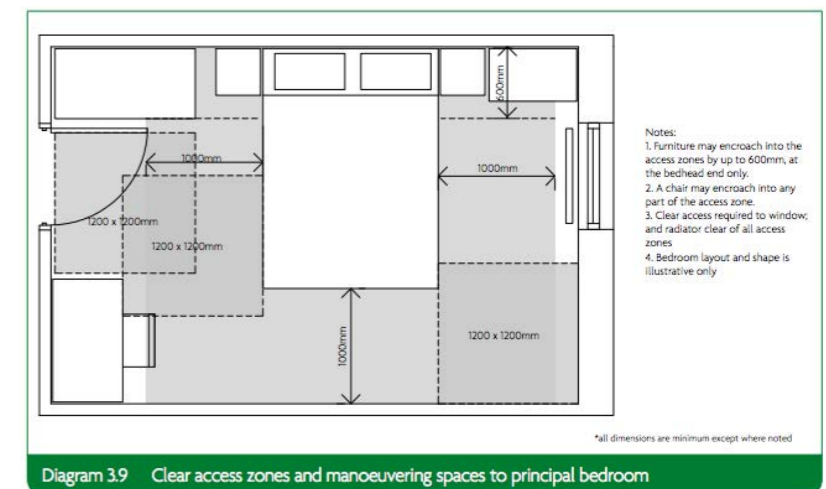

Diagram 3.9 Clear access zones and manoeuvring spaces to principal bedroom

Sanitary facilities

All wheelchair dwellings meet the requirements of table 3.5.

Every wheelchair dwellings provides a wet room on the entrance storey which contains a WC, wash hand basin and installed level access shower and features an outward opening door.

The (adaptable) dwellings have bathrooms which comply with diagram 3.10 and can be easily adapted in future to become wheelchair accessible.

The (accessible) dwellings have bathrooms which comply with diagram 3.11.

All 2 and 3 bedroom apartments have a principle compliant bathroom and a separate compliant en-suite for the master bedroom, with outward opening doors.

All principle bathrooms and en-suites provide a minimum 1500mm clear wheelchair turning circle. This applies to both adaptable and accessible units.

Table 3.5 Summary of minimum requirements for sanitary provision in typical dwelling types (dwellings should also comply with relevant detailed requirements set out in paragraphs 3.36-3.43)

Occupancy	Typical minimum sanitary provision
Single storey dwelling (typically a flat or bungalow)	
2 or 3 bedspaces	Bathroom with level access shower
4 bedspaces	Bathroom with level access shower and separate WC/cloakroom
5 bedspaces or more	Bathroom with level access shower and separate WC/cloakroom (or second bathroom). Wheelchair accessible dwellings must also provide both a level access shower and a bath
Two or three storey dwelling (typically a house or maisonette)	
2 or 3 bedspaces	Bathroom with level access shower on same level as principal bedroom + entrance storey WC/cloakroom (where bathroom not on the entrance storey)
4 bedspaces	Bathroom with level access shower on same level as principal bedroom and entrance storey WC/cloakroom or second bathroom
5 bedspaces or more	Bathroom with level access shower on same level as principal bedroom and entrance storey WC/cloakroom or second bathroom. Wheelchair accessible dwellings must also provide both a level access shower and a bath

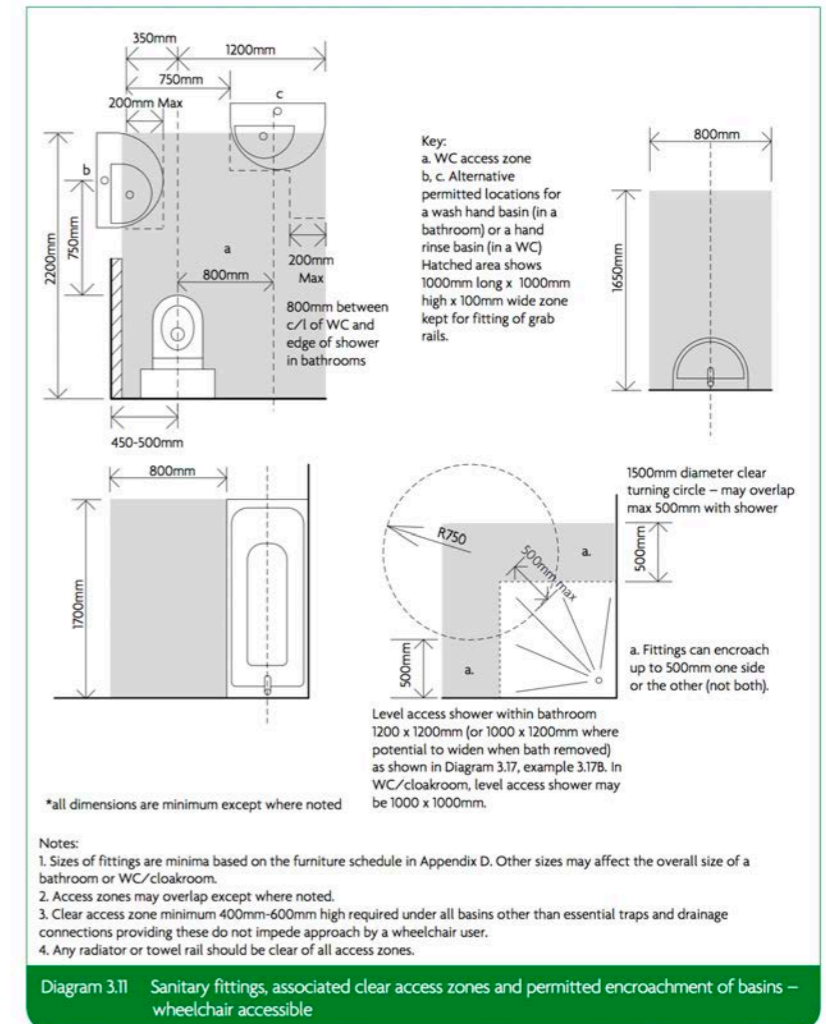
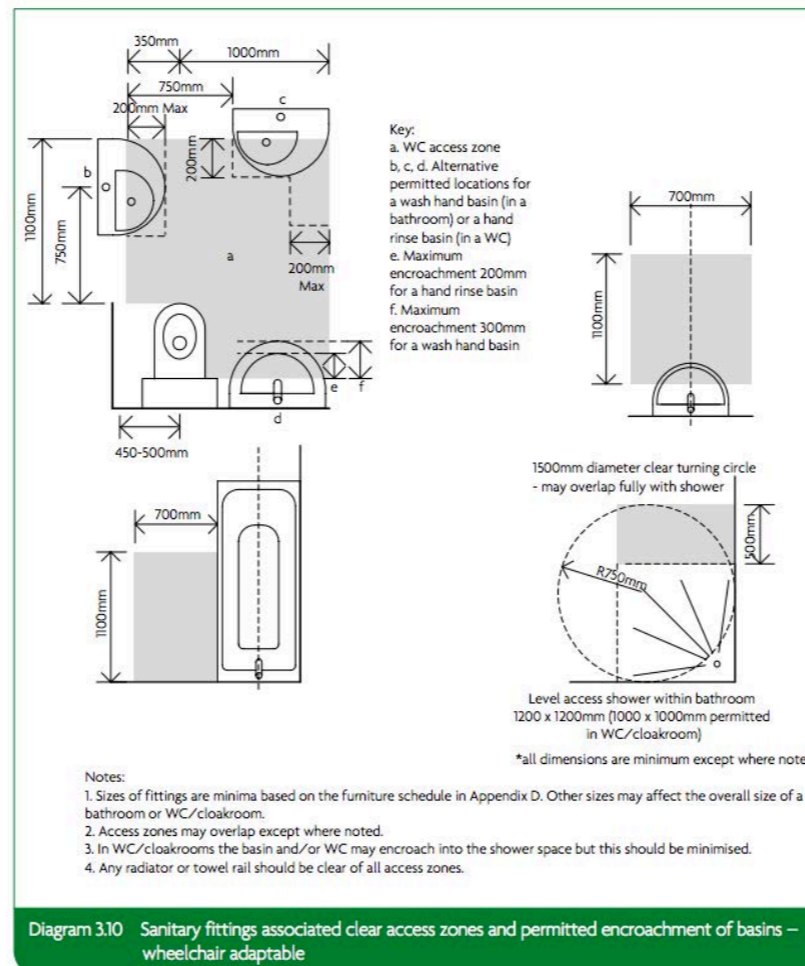

6.13.1 Typical M4(3) 2 bedroom flat

- Generous window provision
- Private amenity space off the living room
- Ample storage and generous wardrobe space
- 2 bathrooms
- Entrance lobby minimum of 1500mm wide
- Area to store wheelchair besides door
- Standard corridor width of 1050mm
- Minimum living room width of 4.2m
- 1500mm between kitchen cabinets

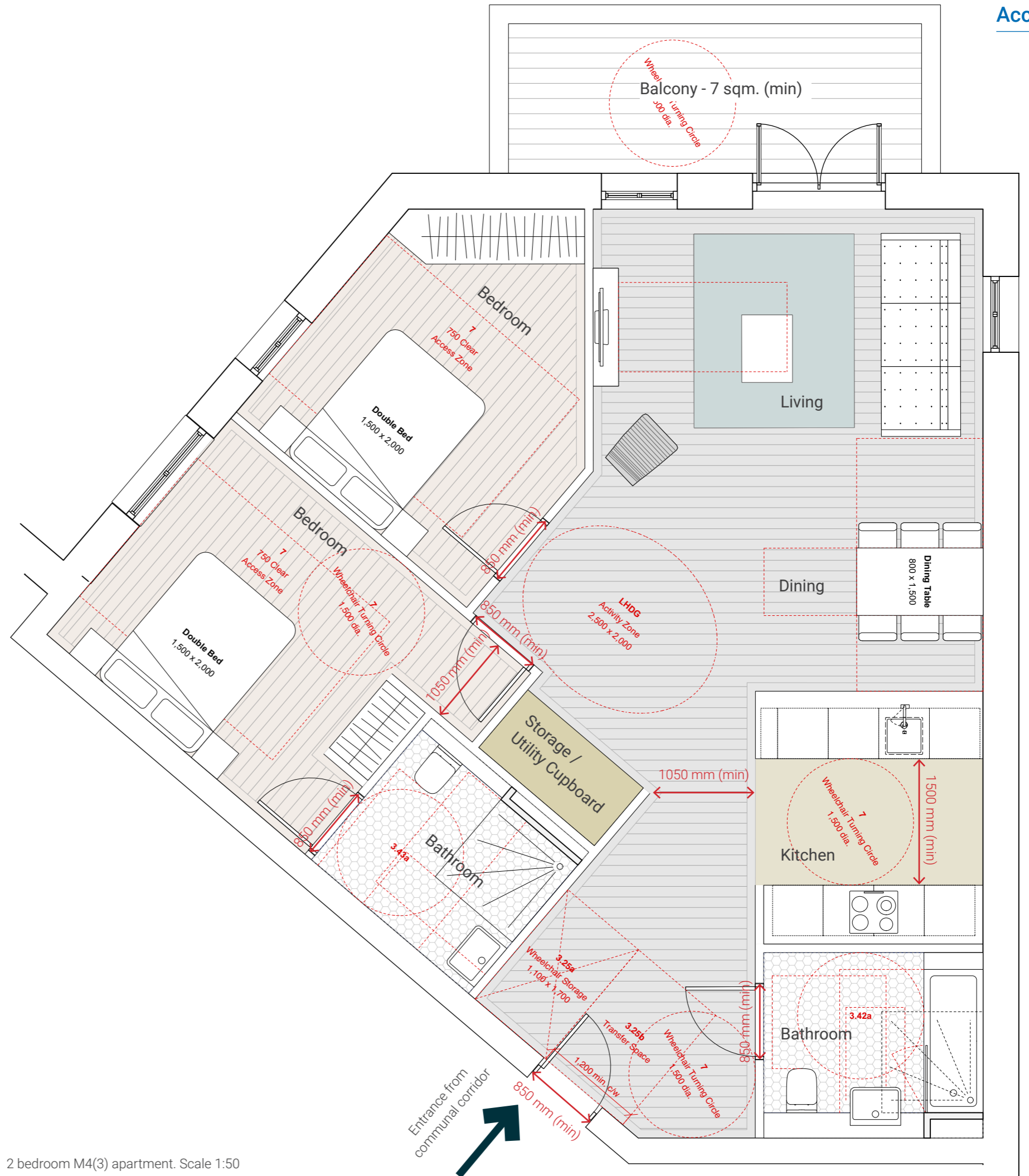
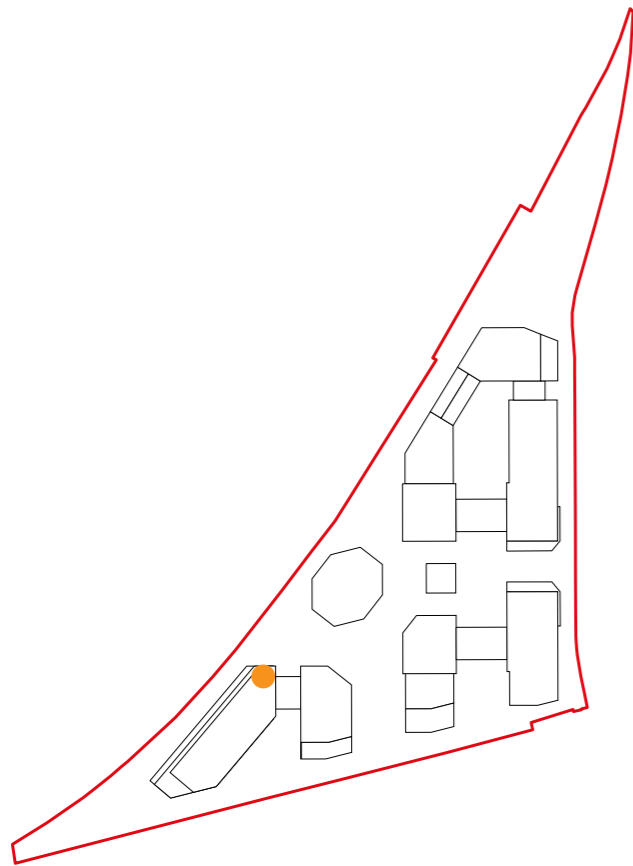

2 bedroom M4(3) apartment. Scale 1:50

6.13.2 Typical M4(2) 3 bedroom flat

- Dual aspect
- Generous window provision
- Private amenity space off the living room
- Ample storage and generous wardrobe space
- 2 bathrooms
- Entrance lobby minimum of 1500mm wide
- Area to store wheelchair besides door
- Standard corridor width of 1050mm
- Minimum living room width of 4.5m
- 1500mm between kitchen cabinets

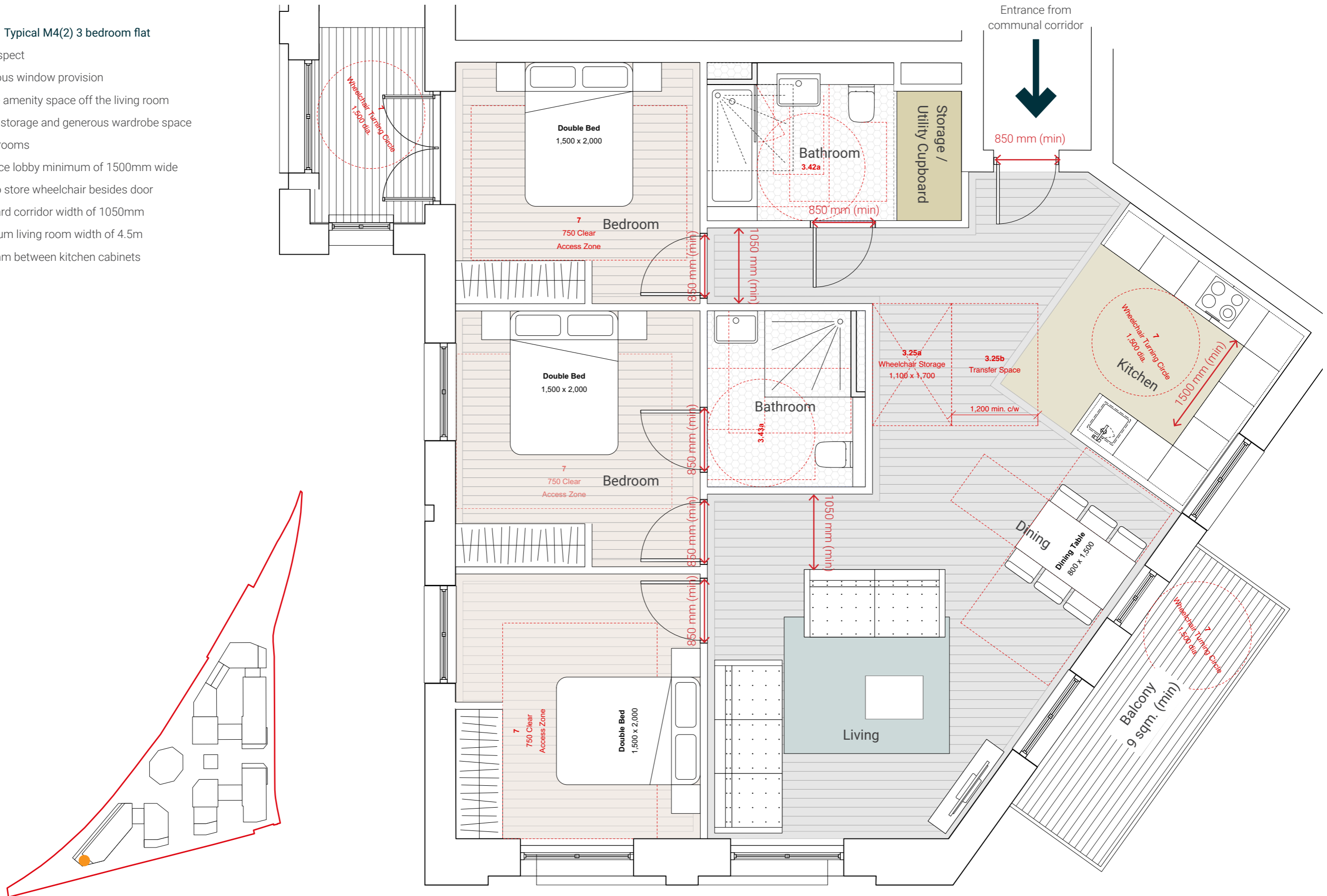

3 bedroom M4(3) apartment. Scale 1:50

6.14 Multi-level units

6.14.1 Duplex apartments

There are 6 duplex apartments across the scheme, located within blocks C and D. The typology of these units reference townhouses across the borough.

Each of the duplexes has it's own private entrances via steps from the public realm to the front door and down to a private terrace. In each of these instances an additional entrance is located on the upper ground floor at the rear of the apartment providing level access to the communal corridor, core, cycle and refuse store.

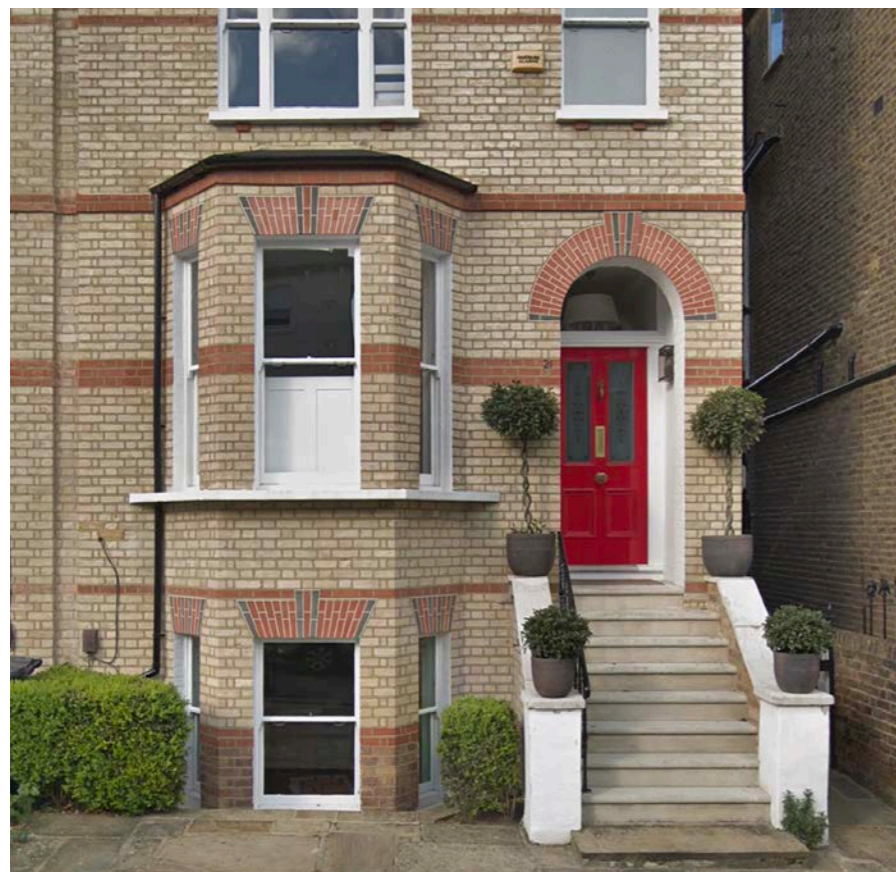

Duplex flat along Mount Ararat Road, Richmond

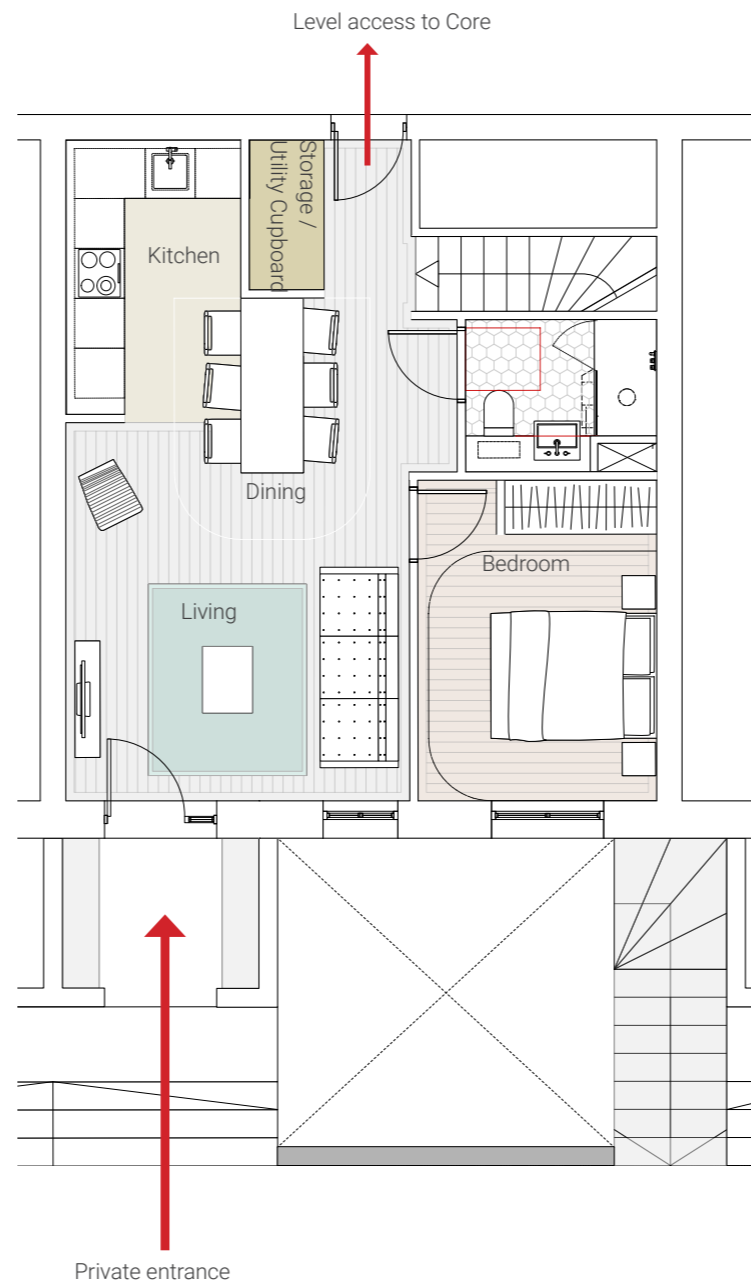

Typical duplex, upper ground floor plan.

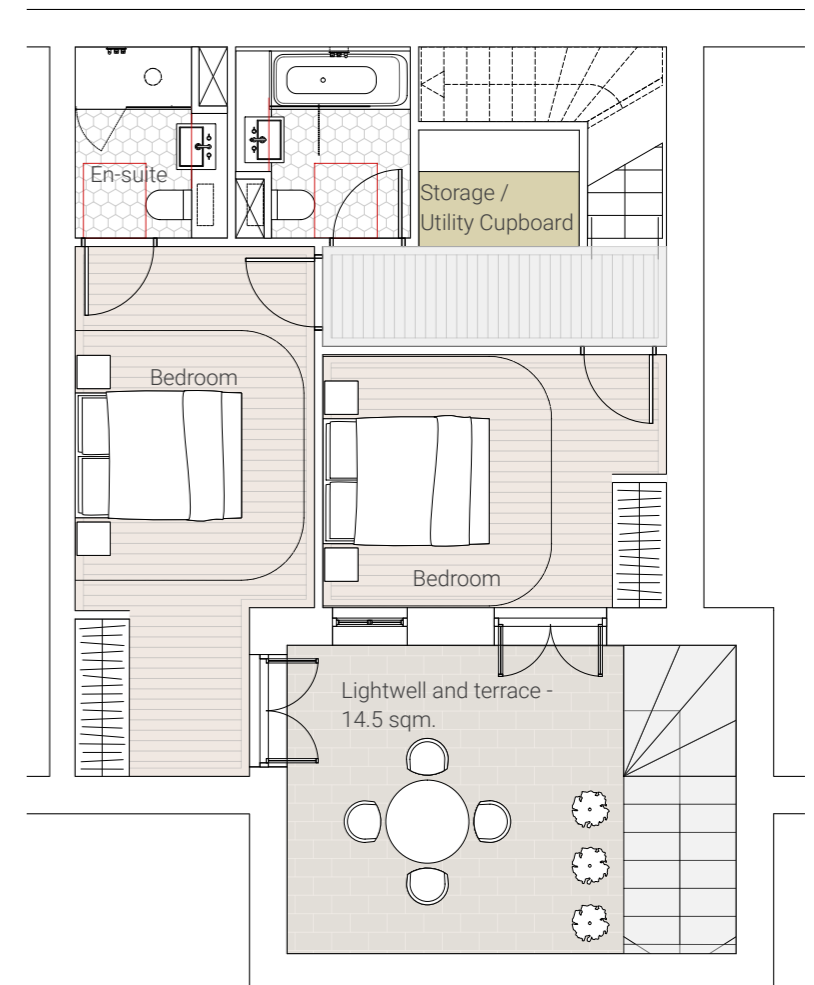

Typical duplex, lower ground floor plan.

6.14.2 Townhouses

There are 3 townhouses included in the proposals.

Each of the townhouses has it's own private entrances via steps from the access road to the rear. In each of these instances an additional entrance is located on the ground floor providing level access to the communal courtyard.

Each townhouse will have a private roof terrace on the 2nd floor, they will also have storage space for bicycles facing the access road.

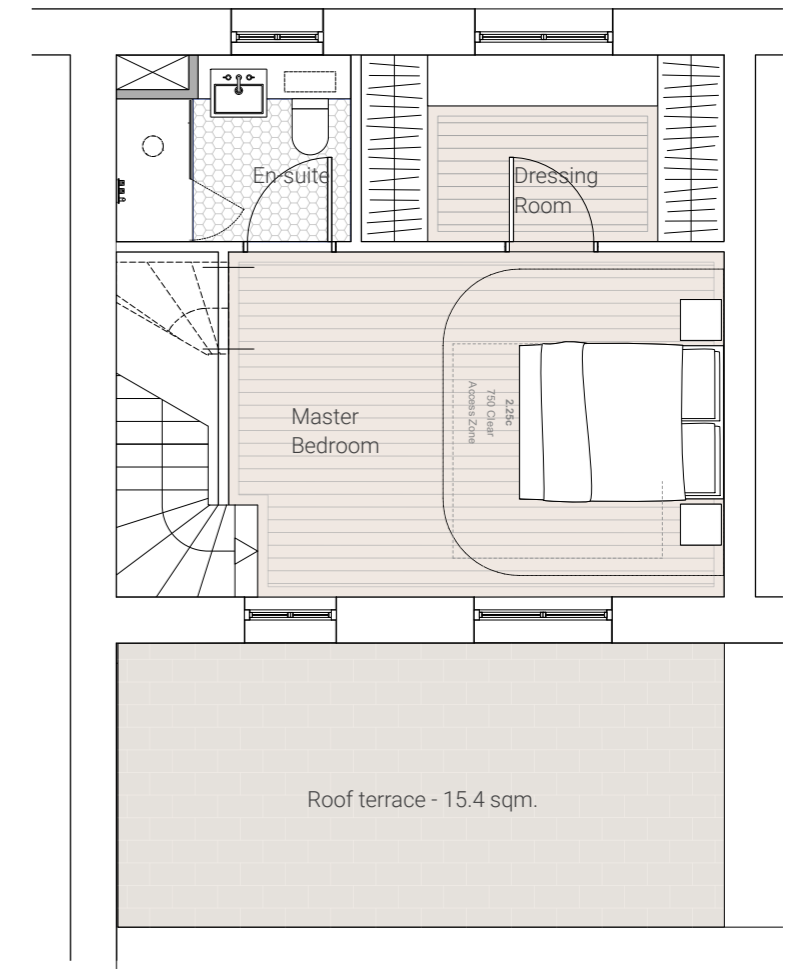
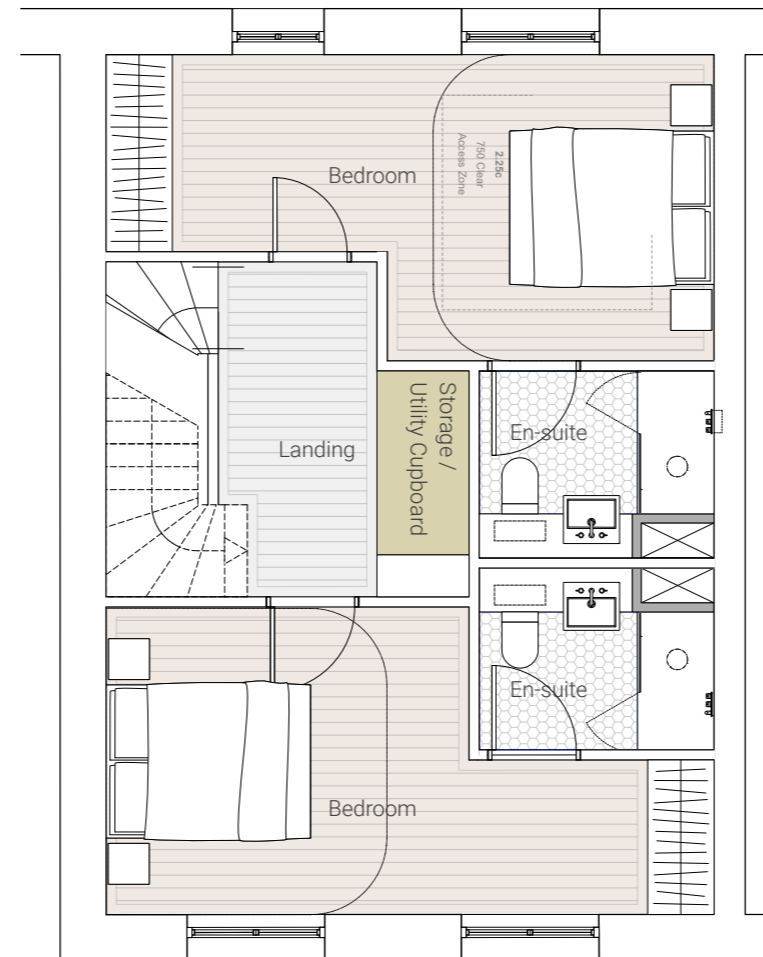
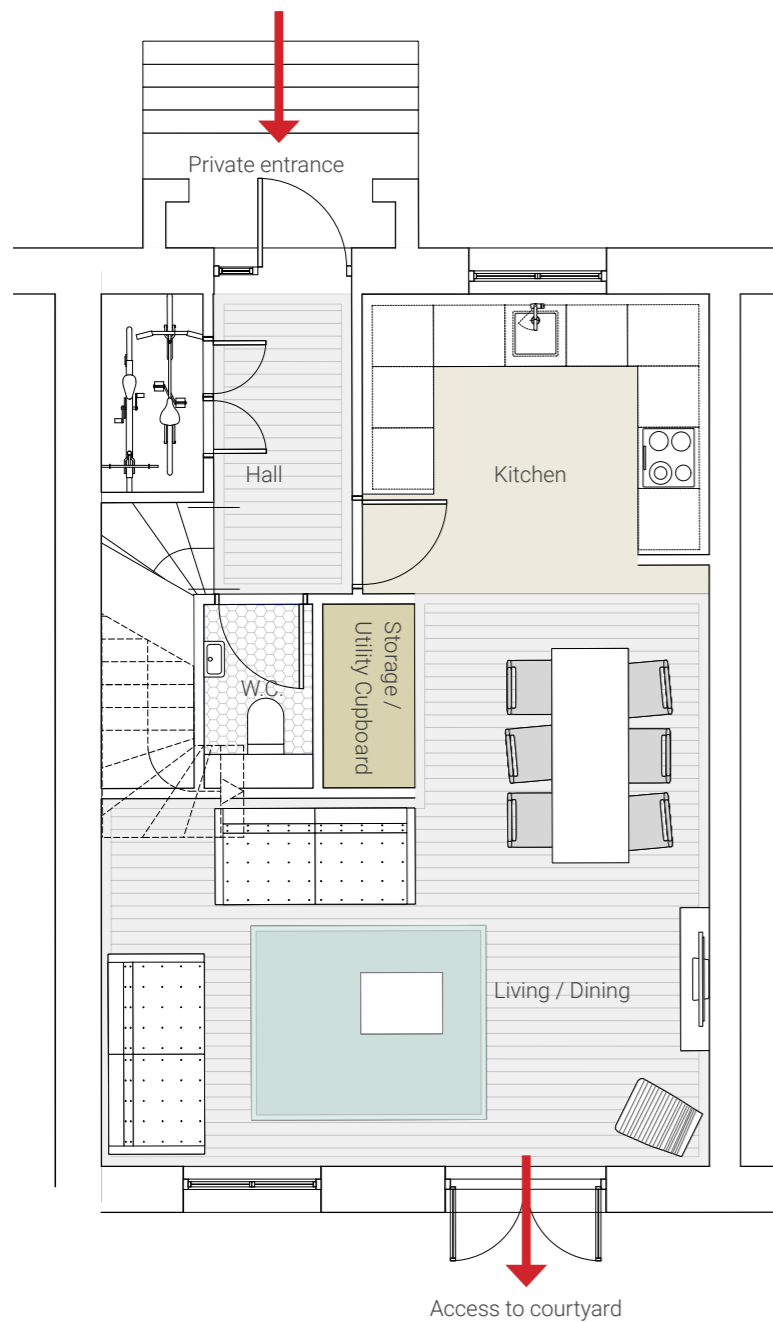

Typical townhouse, ground floor plan.

Typical townhouse, first floor plan.

Typical townhouse, second floor plan.

Introduction

Context

Design process

Design response

Landscape

Access

7.0 Appendices

7.1 Phasing

The project is to be delivered in a series of phases, detailed in the diagrams, right.

- We will enforce that working hours for the construction works will be restricted to those agreed with the Council.
- Safety is our main concern. The site will be fully hoarded to ensure no unauthorised access or injury to a member of the public.
- We will insist that the main contractor will provide 24-hour security and that deliveries to/from the construction site will be carefully managed by the main contractor.

Demolition and enabling plan

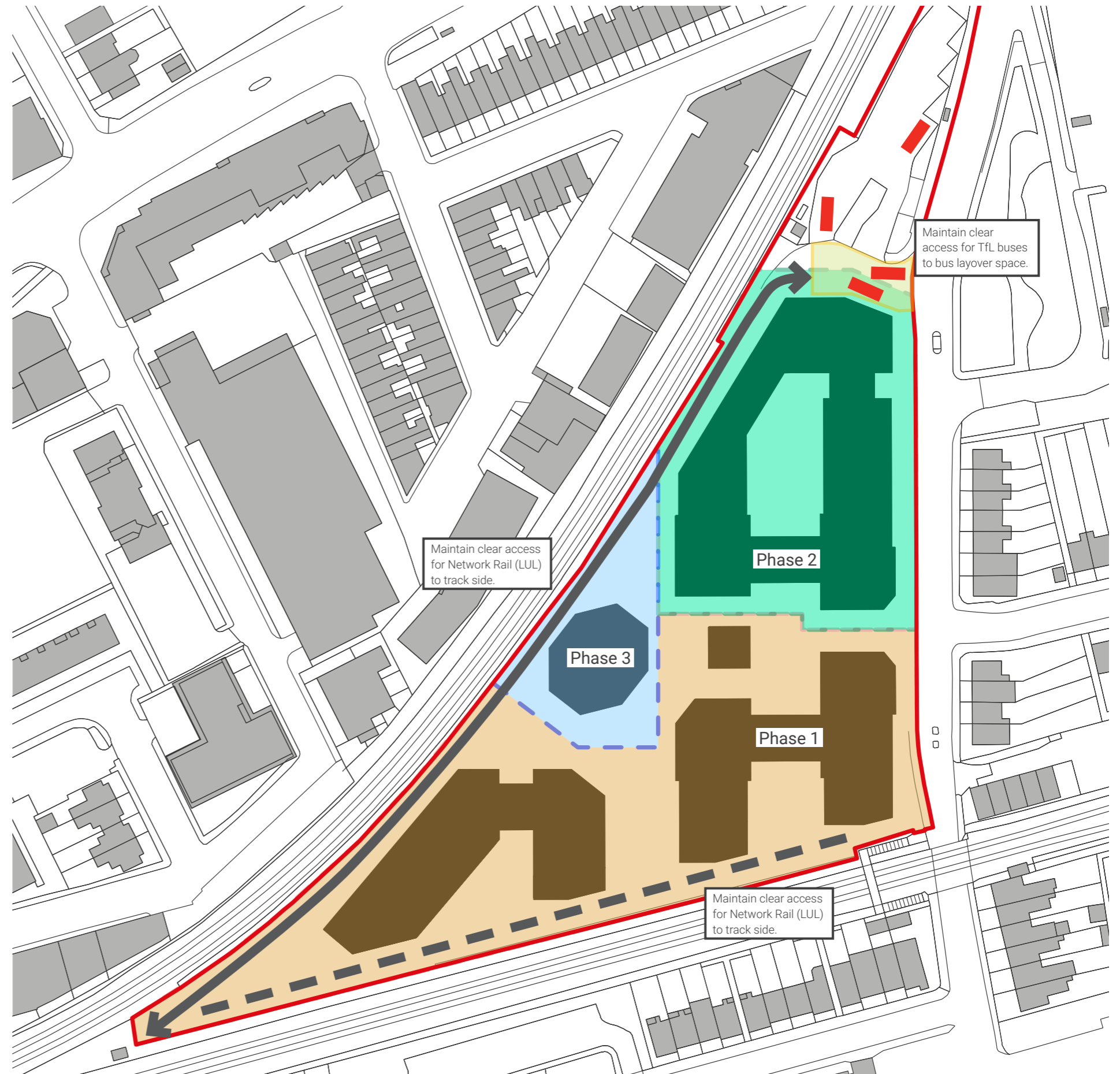
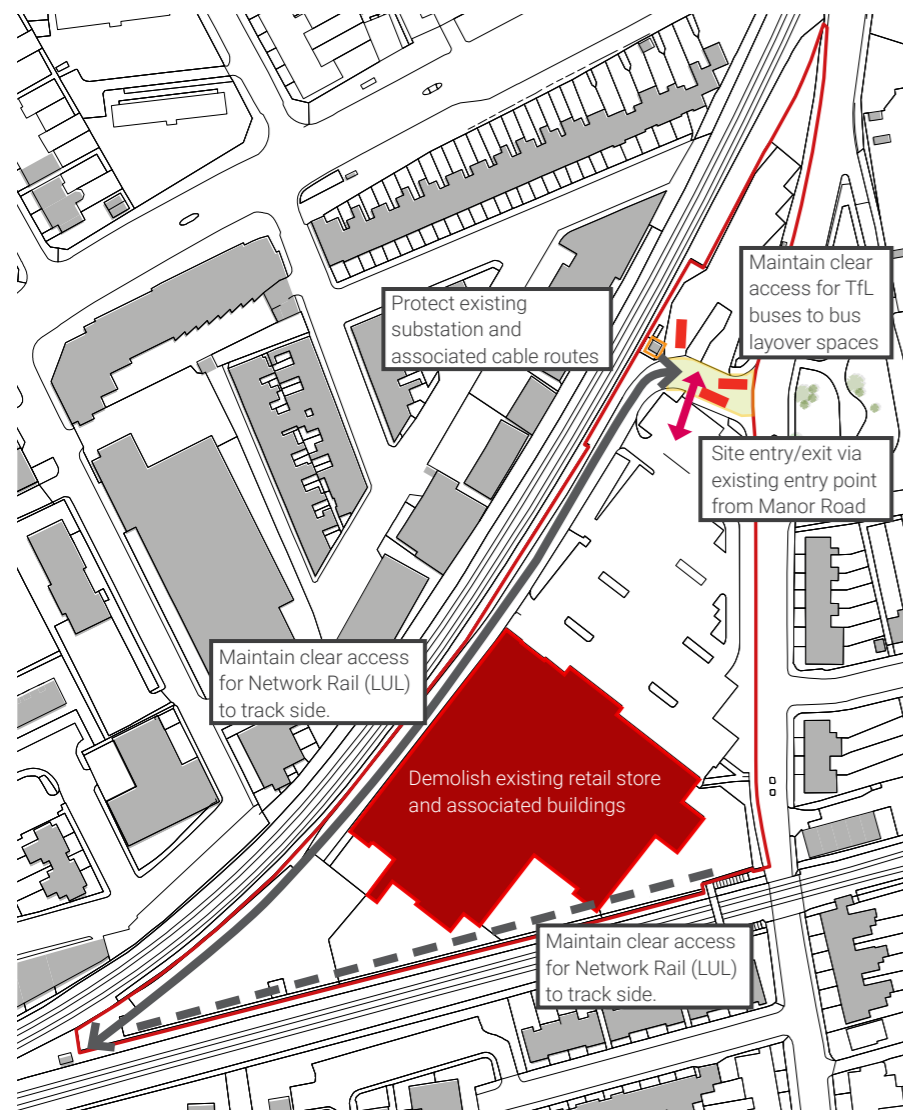

Overall phasing strategy

Phase 1 including access road and utilities

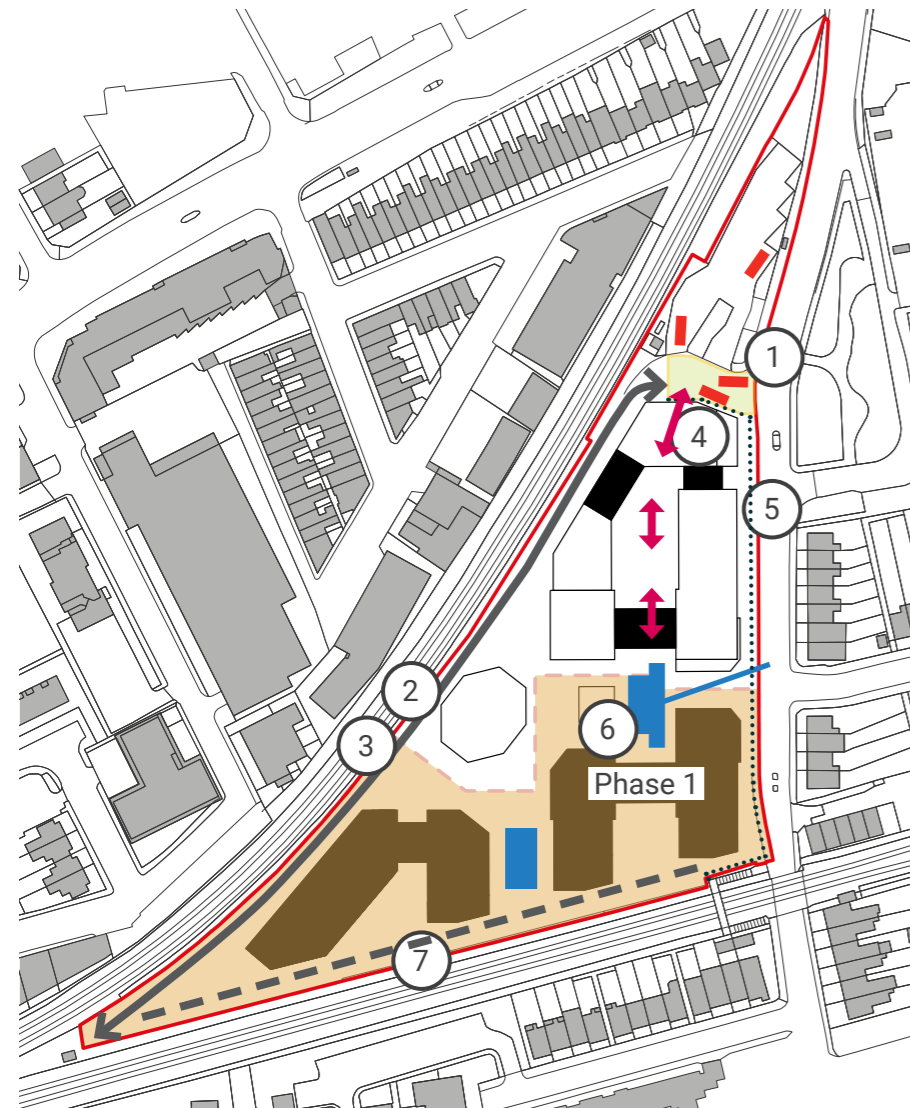

1. Maintain clear access for TfL buses to bus layover space.
2. Maintain clear access for Network Rail (LUL) to track side.
3. Phased construction of new access road whilst maintaining track side access for Network Rail/LUL.
4. Site entry/exit via existing entry point from Manor Road
5. Site hoarding line retaining public footway
6. Phase 1 construct drainage infiltration crates and drainage connections
7. Maintain clear access for Network Rail to track side.

Phase 2

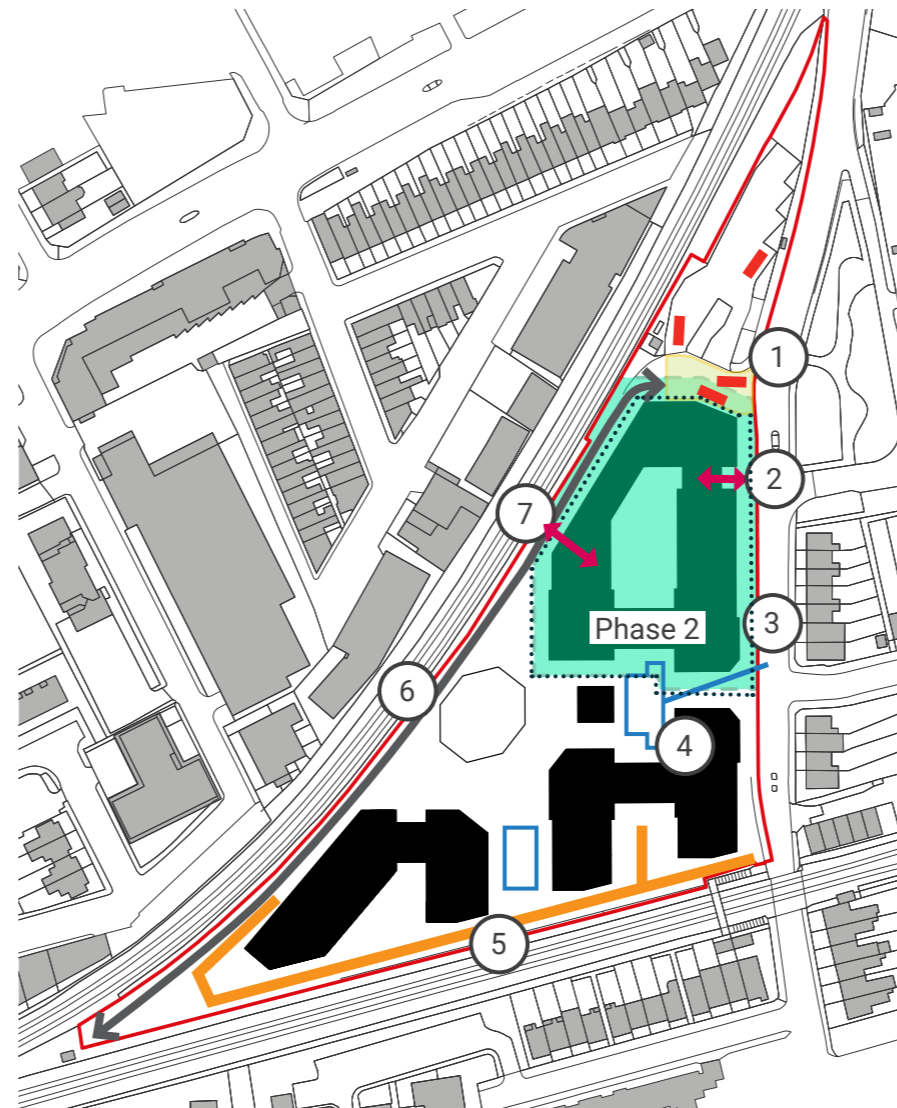

1. Maintain clear access for TfL buses to bus layover space.
2. Site entry/exit via Manor Road - possible relocation during superstructure works.
3. Site hoarding line retaining public footway.
4. Phase 1 drainage optional.
5. Maintain safe and secure clear access for occupants of early phases.
6. New access road operational for access to Phase 1 with area kept clear for LUL/ NR access.
7. Potential site entry/exit from new access road.

Phase 3

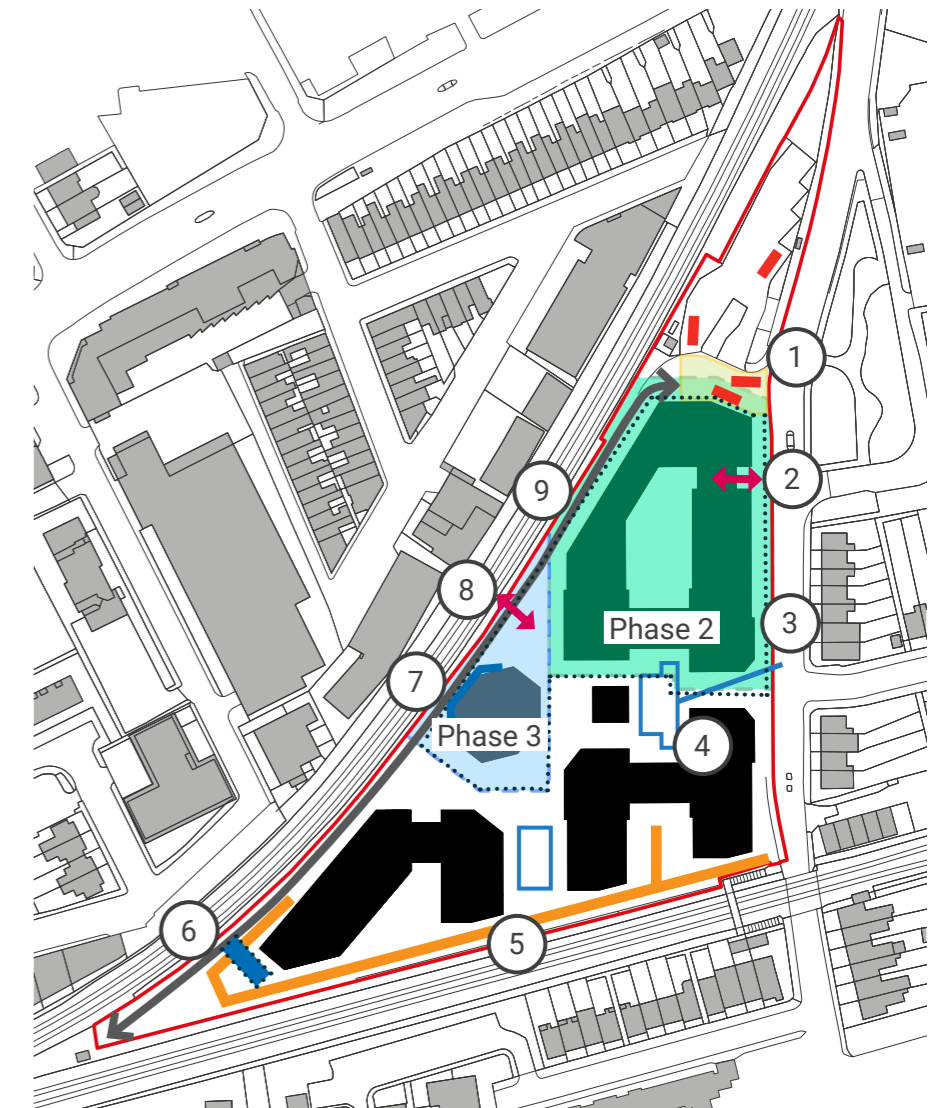

1. Maintain clear access for TfL buses to bus layover space.
2. Site entry/exit via Manor Road - possible relocation during superstructure works.
3. Site hoarding line retaining public footway.
4. Phase 1 drainage optional.
5. Maintain safe and secure clear access for occupants of early phases.
6. Possibly need to use this or another area as a turning head for delivery vehicles to Phase 3
7. Protection required for user of access road.
8. Site entry/exit from new access road.
9. New access road operational for access to phase 1 with area kept clear for LUL/ NR access.

7.2 Sustainability

Hoare Lea have prepared both a Sustainability Statement and Energy Statement in support of this application.

A summary is provided below.

Building Materials

A palette of high quality materials have been proposed for the development. The BRE's Green Guide to Specification will be used to ensure that A-rated materials make up the majority of a material elements where practicable.

Water

Water use will be reduced as much as possible mainly through the specification of efficient sanitary ware and water efficient fittings. All dwellings will be designed to comply with the requirements of Building Regulations Part G, and water use will be set at 105 (litres/person/day).

Water Recycling

Sustainable irrigation systems will be incorporated into the landscaping design to ensure a strong ecological value of the site is withheld throughout its life cycle. The design proposal includes an external drainage irrigation board underneath all landscaping areas in the development to enable collection and recycling of the rainwater which falls on the landscaped areas.

Energy

The proposed development will be powered using air source heat pumps to minimise impact on local air quality and reduce carbon emissions.

Sustainable Urban Drainage Systems (SuDS) Measures

The site will aim to implement sustainable drainage systems (SuDS) to aid the collection, storage and treatment of the surface water prior to discharging from site.

The inclusion of attenuation tanks below the new public square and within the southern landscaped areas will ensure minimum surface water run off and reduce the risk of flooding in the future.

Blue roofs are proposed across all roofs.

Biodiversity

Green/brown roofs are proposed on all roofs where there is no requirement for plant. This will incorporate a mixture of wildflower species as well as herbs and grasses.

We also intend to propose high level bat boxes along the southern elevation, facing the railway line following feedback from our ecologist. The design for these will be developed at the next stage.

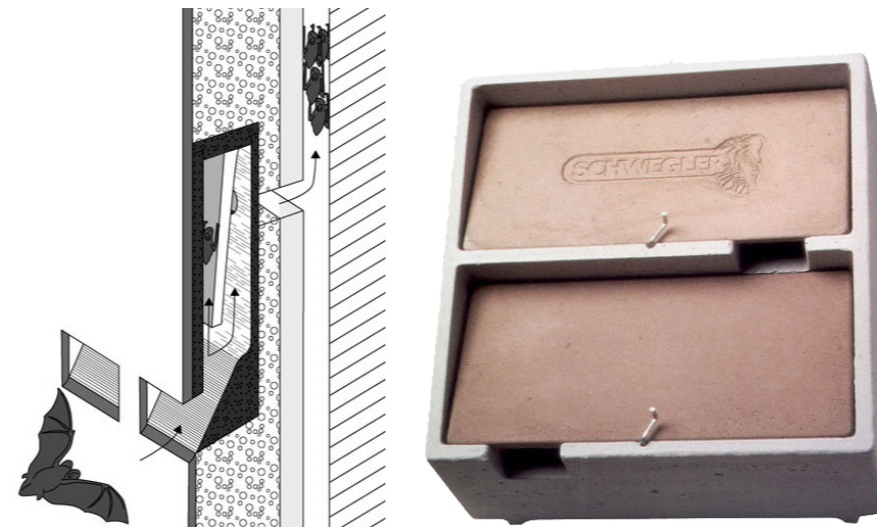





Example schwegler bat box



Green roof example







7.3 Sustainability checkpoint assessment

Stage 0		
Guidance		
<p>Obtain information about the site and / or structures for constraints and opportunities</p> <p>‘Awareness’ stage and setting the sustainability context for the project.</p> <p>Review client requirements to distil their sustainability aspirations and the expected building lifespan against which capital costs should be balanced against costs in use.</p> <p>Identify potential for cost effective enhancement of client aspirations.</p> <p>Review options for formal assessment of aspects of sustainability and/or energy performance (e.g. BREEAM, LEED, Passivhaus). If the project is a component of a larger scheme, ensure that targets support and are consistent with any overarching sustainability assessment methodologies. Establish timetable for associated assessor appointment and early stage actions.</p> <p>Client to consider appointing or identifying a client sustainability advocate (in senior management position) and/or appointing a sustainability champion in the design team.</p> <p>Assess environmental opportunities and constraints of potential sites and building assets including sufficient iterative modelling to support conclusions of feasibility studies.</p> <p>Initial consultation with stakeholders, identification of local planning sustainability requirements and appraisal of existing building, social, transportation, water, energy, ecological and renewable resources, including the need for pre-construction or seasonal monitoring or surveys.</p> <p>Commission surveys of existing buildings to be retained (including condition, historic/ townscape significance, materials and components for recycling), services, noise, vibration, renewable energy resources, ecology, geology, etc. as required) to inform the brief.</p> <p>Identify potential funding sources and their eligibility criteria.</p> <p>Review relevant current and emerging EU, national and local sustainability policy and legislation and analyse implications on build, environmental and performance targets.</p> <p>Identify and understand final occupants’ needs to help to establish user patterns, energy profile and performance standards required.</p> <p>Client to consider the formal adoption of a Soft Landings approach to the project (www.bsria.co.uk/services/design/soft-landings/).</p> <p>Client to consider appointing a Soft Landings champion.</p> <p>Client to consider merits and protocols of using a building information model (BIM) to help deliver sustainability aims.</p>		
Sustainability checkpoint	Check	Comments
Has the site information letter been sent, any response entered onto the site information record and disseminated to other consultants?		
Ensure that a strategic sustainability review of client needs and potential sites has been carried out, including reuse of existing facilities, building components or materials.		

-  Completed
-  Partially complete (see comments)
-  Not complete (see comments)

Sustainability checkpoints are from RIBA Plan of Work 2013 and guidance notes originate from the 2011 Green Overlay to the RIBA Outline Plan of Work, supplemented with Assael Architecture’s procedural guidance.

Guidance notes and checkpoint assessments are for the attention and implementation of the entire project team, including the client, and should be part of all stage reports.

Stage 1		
Guidance		
<p>Obtain screening letter from planning authority to verify sustainability requirements.</p> <p>Include a simple description in the brief of the internal environmental conditions the client requires.</p> <p>Involve the client’s facilities management team and review past experience (good and bad) in a spirit of openness in order to set environmental and performance targets that are useful, measurable, challenging but achievable and unambiguous. Targets should include both regulated and unregulated energy.</p> <p>Develop water efficiency strategies to establish similarly robust performance targets.</p> <p>Agree how to measure performance in use, what incentives there will be to achieve performance objectives and what action is appropriate if anything falls short.</p> <p>Develop potential energy strategies for the site including iterative estimated energy demand calculations, options for renewables and implications on building/ site design (e.g.sufficient plant space).</p> <p>Set out SUDS and surface water retention requirements.</p> <p>Develop a brief for specialist environmental sub-consultants (e.g. wind monitoring consultant, ecologist).</p> <p>Consider Climate Change Adaptation criteria and future performance standards.</p> <p>Set out any future uses or reconfiguration to be accommodated.</p> <p>Ensure that competence of potential design team members matches the client’s sustainability aspirations. The team should be balanced, with members of similar competence and commitment and with complementary contracts of engagement.</p> <p>Client to start the Site Waste Management Plan (SWMP) to enable designers to record decisions made to reduce waste as the project progresses.</p>		
Sustainability checkpoint	Check	Comments
Has the site information letter been sent, any response entered onto the site information record and disseminated to other consultants?		
Confirm that formal sustainability targets are stated in the Initial Project Brief.		
Confirm that environmental requirements, building lifespan and future climate parameters are stated in the Initial Project Brief.		
Have early stage consultations, surveys or monitoring been undertaken as necessary to meet sustainability criteria or assessment procedures?		Yes sustainability consultant appointed.
Check that the principles of the Handover Strategy and post-completion services are included in each party’s Schedule of Services.		
Confirm that the Site Waste Management Strategy has been considered.		Yes waste consultant appointed.

Stage 2		
Guidance		
<p>Set out site scale environmental design criteria (e.g. solar orientation, overshadowing, SUDS, waste).</p> <p>Consider the design of the space between buildings as well as the buildings themselves.</p> <p>Consider the need for and scale of private, semi-private and public external space.</p> <p>Establish maximum plan depths to achieve desired levels of natural ventilation, daylight and view.</p> <p>Design for buildability, usability and manageability.</p> <p>Consider the impact of complexity of form on thermal performance, airtightness, and inefficient/wasteful use of materials.</p> <p>Establish an appropriate glazing proportion and shading strategy for each orientation to provide good levels of daylight while avoiding excessive glare, solar gain or heat loss.</p> <p>Establish appropriate element thicknesses to achieve U-values required by energy strategy.</p> <p>Check that materials and construction approach will provide a level of thermal mass that is appropriate to the environmental design strategy.</p> <p>Refine and review design decisions to minimise quantity of materials used and to minimise construction waste (for guidance, see www.wrap.org.uk/designingoutwaste).</p> <p>Review the embodied impacts of materials and construction approach in the context of the building's lifespan.</p> <p>Avoid design solutions that inhibit adaptation and alternative use of the building or its components and materials.</p> <p>Take particular care to avoid short- and long-term damage to retained traditional building fabric from ill-considered upgrade interventions.</p> <p>Ensure that design implications of any components essential to the success of a sustainability strategy are understood across the design team (e.g. space for fuel deliveries and waste handling, roof collector area and orientation, location and size of rainwater harvesting tanks, SUDS attenuation, etc.).</p> <p>Refine energy and servicing strategy, incorporating energy efficient services design and design techniques.</p> <p>Carry out sufficient compliance or advanced modelling to prove the design concept before freezing the design (e.g. SBEM/SAP/PHPP (Passivhaus Planning Package) or dynamic modelling).</p> <p>Audit the emerging design against project's sustainability agenda and targets.</p> <p>Set up a programme of intermediate evaluations and reality checks involving stakeholders and key users as well as the design team.</p>		
Sustainability checkpoint	Check	Comments
Confirm that formal sustainability pre-assessment and identification of key areas of design focus have been undertaken and that any deviation from the Sustainability Aspirations has been reported and agreed.		
Has the initial Building Regulations Part L assessment been carried out?		
Have 'plain English' descriptions of internal environmental conditions and seasonal control strategies and systems been prepared?		
Has the environmental impact of key materials and the Construction Strategy been considered?		
Has resilience to future changes in climate been considered?		

7.4 London Mayor’s Housing SPG compliance matrix



With reference to: Housing SPG March 2016, London Plan 2016 Implementation Framework

The Mayor of London’s 2016 Housing SPG sets out 41 standards that apply to all new housing in London under policy 3.5 of the London Plan. The compliance schedule below assesses this proposal in relation to these standards:

The Interim London Housing Design guide 2010(LHDG) is now superseded by the SPG.

Standard	Compliance	Comments
Defining good places		
1	Development proposals should demonstrate: a) How the design responds to its physical context, including the character and legibility of the area and the local pattern of building, public space, landscape and topography. b) How the scheme relates to the identified character of the place, to the local vision and strategy or how bolder change is justified in relation to a coherent set of ideas for the place expressed in the local vision and strategy or agreed locally.	Refer to Design and Access Statement
2	Development proposals should demonstrate: a) How the scheme complements the local network of public spaces, including how it integrates with existing streets and paths. b) How public spaces and pedestrian routes are designed to be overlooked and safe, and blank elevations onto the public realm at ground floor have been avoided. c) For larger developments, how any new public spaces including streets and paths are designed on the basis of an understanding of the planned role and character of these spaces within the local movement network, and how new spaces relate to the local vision and strategy for the area.	
Communal and public open space		
3	Development proposals should demonstrate that they comply with the LPAs’ open space strategies, ensuring that an audit of surrounding open space is undertaken and that, where appropriate, opportunities to help address a deficiency in provision by providing new public open spaces are taken forward in the design process.	
4	Where communal open space is provided, development proposals should demonstrate that the space: • is overlooked by surrounding development; • is accessible for disabled people including people who require level access and wheelchair users; • is designed to take advantage of direct sunlight; • has suitable management arrangements in place.	
Play space		
5 (& policy 3.6)	For developments with an estimated occupancy of ten children or more, development proposals should make appropriate play provision in accordance with the Mayor’s Play and Informal Recreation SPG.	Development provides on-site play provision for 0-11 yr old children. Children aged 12+ are to use local facilities within 800m of site.









Key

-  Fully compliant
-  Partially compliant (see comments)
-  Not compliant (see comments)

Standard	Compliance	Comments
Density		
6 (& policy 3.4)	Development proposals should demonstrate how the density of residential accommodation satisfies London Plan policy relating to public transport access levels (PTALs) and the accessibility of local amenities and services, and is appropriate to the location	
Residential mix		
7 (& policy 3.8)	Development proposals should demonstrate how the mix of dwelling types and sizes and the mix of tenures meet strategic and local need and are appropriate to the location.	
Entrance and approach		
8	All main entrances to houses, ground floor flats and communal entrance lobbies should be visible, clearly identifiable, and directly accessible from the public realm.	Block C, core B accessed via shared surface to the eastern edge of the site. All other cores front new public square or have frontage along Manor Road.
9	The distance from the accessible car parking space of standard 18 to the home or to the relevant block entrance or lift core should be kept to a minimum and should be preferably level or where level is not possible, gently sloping (1:60 – 1:20) on a suitable ground surface.	All parking spaces have level access. Minimum parking paces provided on site (3% of units). Distance from parking spaces to apartments in excess of 18m.
Active frontages		
10	Active frontages should be maximised and inactive frontages minimised on the ground floor of buildings facing publicly accessible space, in order to provide natural surveillance and activity.	All commercial frontage concentrated at entrance and most public areas of the site. Ground floor residential units raised above ground level and screened with planting to provide privacy.
Access		
11	90 per cent of new build housing should meet Building Regulation requirement M4(2) ‘accessible and adaptable dwellings’ with the remaining 10 per cent meeting Building Regulation requirement M4(3) ‘wheelchair user dwellings’.	All market tenure flats meet the M4 (2) specification with 10% of all affordable units meeting the M4 (3) specification.
Shared circulation		
12	Each core should be accessible to generally no more than eight units on each floor.	
13	An access core serving 4 or more dwellings should provide an access control system with entry phones in all dwellings linked to a main front door with electronic lock release. Unless a 24 hour concierge is provided, additional security measures including audio-visual verification to the access control system should be provided where any of the following apply: • more than 25 dwellings are served by one core, or • the potential occupancy of the dwellings served by one core exceeds 100 bed spaces, or • more than 8 dwellings are provided per floor.	24hr concierge.

Standard	Compliance	Comments
14		
15		
16		
Car parking		
17		Car-free development. 3% of units have access to accessible parking bay. This number can be increased to 10% of units if required.
18		
19		Car-parking spaces located along western access road.
Cycle storage		
20		
21		
Refuse and recycling facilities		
22		
23		

Standard	Compliance	Comments
Dwelling space standards		
24		
25		
Private open space		
26		
27		
Privacy		
28		
Dual aspect		
29		55% of all dwellings are dual aspect. This number increases to 65% if you include apartments with bay windows in the count. There are 10 single aspect units. All benefit from a bay window and are 1 beds.
Noise		
30 (& policy 7.15)		
Floor to ceiling heights		
31		Floor to ceiling heights are all 2.65m high.
Daylight and sunlight		
32		
Air quality		
33 (& policy 7.14)		Air source heat pumps selected as energy strategy to minimise air pollution.

Standard	Compliance	Comments							
Environmental performance									
34 (& policy 5.3)	All homes should satisfy London Plan policy on sustainable design and construction and make the fullest contribution to the mitigation of and adaptation to climate change.								
Energy and CO₂									
35 (& policy 5.2)	<p>Development proposals should be designed in accordance with the LP energy hierarchy, and should meet the following minimum targets for carbon dioxide emissions reduction.</p> <table border="1" data-bbox="261 554 635 709"> <thead> <tr> <th>Year</th> <th>Improvement on 2013 Building Regulations</th> </tr> </thead> <tbody> <tr> <td>2014 - 2016</td> <td>35 per cent¹</td> </tr> <tr> <td>2016 - 2036</td> <td>Zero carbon</td> </tr> </tbody> </table> <p><small>¹ As set out in the Mayor's Sustainable Design and Construction SPG 2014 (paragraph 2.4.3) and the Energy Planning - GLA Guidance on preparing energy assessments.</small></p>	Year	Improvement on 2013 Building Regulations	2014 - 2016	35 per cent ¹	2016 - 2036	Zero carbon		See sustainability report
Year	Improvement on 2013 Building Regulations								
2014 - 2016	35 per cent ¹								
2016 - 2036	Zero carbon								
Overheating									
36 (& policy 5.9)	Development proposals should demonstrate how the design of dwellings will avoid overheating without reliance on energy intensive mechanical cooling systems.		TM59 studies completed to minimise overheating.						
Water									
37 (& policy 5.15)	<p>New dwellings should be designed to ensure that a maximum of 105¹ litres of water is consumed per person per day in line with the optional requirement of Part G.</p> <p><small>¹ Excluding an allowance of 5 litres or less per head per day for external water use (as set out in MALP and 'optional' Requirement G2 of Schedule 1 to the Building Regulations 2010)</small></p>		See sustainability report						
Flooding and drainage									
38 (& policy 5.12)	<p>Where development is permitted in an area at risk of flooding, it should incorporate flood resilient design in accordance with the NPPF and its associated technical Guidance whilst ensuring level access is maintained.</p> <p><small>¹ Technical Guidance to the National Planning Policy Framework, Department for Communities and Local Government, March 2012 or any subsequent guidance on flood risk issued in support of the NPPF</small></p>								
39 (& policies 5.11 & 5.13)	New development should incorporate Sustainable Urban Drainage Systems and green roofs where practical with the aim of achieving a Greenfield run-off rate, increasing bio-diversity and improving water quality. Surface water run-off is to be managed as close to source as possible.		Blue roofs and attenuation tanks included in proposals.						
Ecology									
40 (& policy 7.19)	The design and layout of new residential development should avoid areas of ecological value and seek to enhance the ecological capital of the area in accordance with GLA best practice guidance on biodiversity and nature conservation.								
Design process									
41	Developments should manage existing materials, specify sustainable materials that are robust and fit for purpose and secure the sustainable procurement of materials.								

Assael

Assael Architecture Limited
 123 Upper Richmond Road
 London SW15 2TL

+44 (0)207 736 7744

info@assael.co.uk

www.assael.co.uk

Document Control Form

Project number	A3004
Project title	Manor Road
Document title	Design and Access Statement
Client	Avanton
Document status	Revision R2
Date of issue	19 February 2018
Prepared by	Holly Barker, Architect
Checked by	Tim Chapman Cavanagh, Director

Assael Architecture Limited has prepared this document in accordance with the instructions of the Client under the agreed Terms of Appointment. This document is for the sole and specific use of the Client and Assael Architecture shall not be responsible for any use of the document or its contents for any purpose other than that for which it was prepared and provided. Should the Client require to pass copies of the document to other parties for information, the whole of the report should be so copied, but no professional liability or warranty shall be extended to other parties by Assael Architecture in this connection without the explicit written agreement thereto by Assael Architecture Limited.

© 2018 Assael Architecture Limited

Assael Architecture Limited owns the copyright of this design and document which must not be reproduced in whole or part without the written permission of Assael Architecture Limited.

Computer generated photo montages that may be contained in this document that have an image identification number containing the letters 'AVR' conform to our 'Accurate Visual Representation Methodology' as set out by the London View Management Framework. In the absence of the letters 'AVR' the image cannot be used as proof of visual impact but as an 'impression'.

Status	Revision	Date issued	Prepared by	Checked by
P1	For Comment	14/12/2018	HB	TCC
P2	For Comment	16/01/2019	HB	TCC
P3	For Comment	25/01/2019	HB	TCC
P4	For Comment	04/02/2019	HB	TCC
R1	For Planning	08/02/2019	HB	TCC
R2	For Planning	19/02/2019	HB	JL

 Please consider the environment before printing this document