

DATUM 3.00m

ELEVATION 23

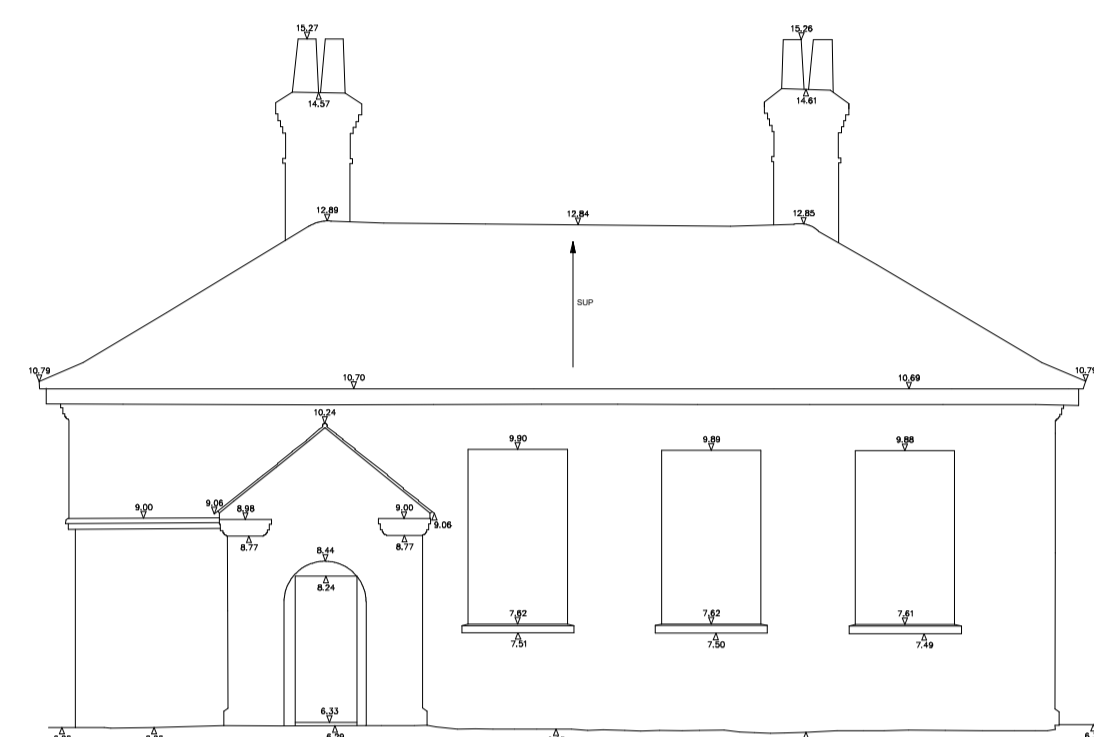

DATUM 3.00m

ELEVATION 24

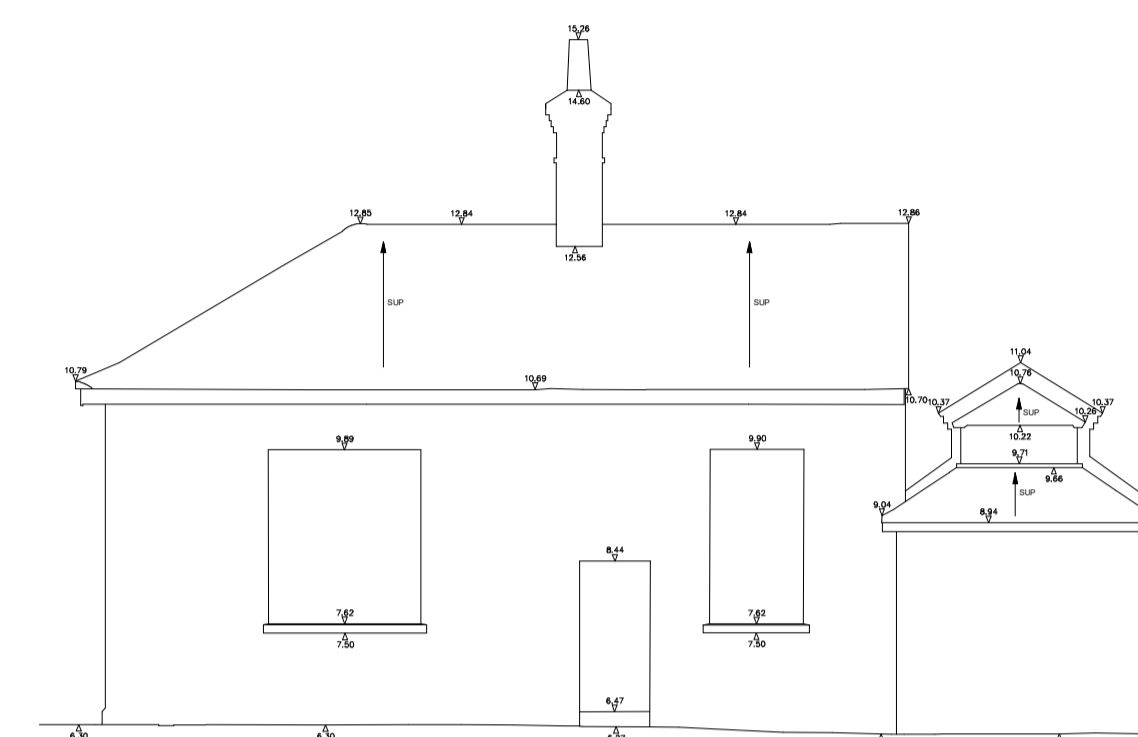

DATUM 3.00m

ELEVATION 25

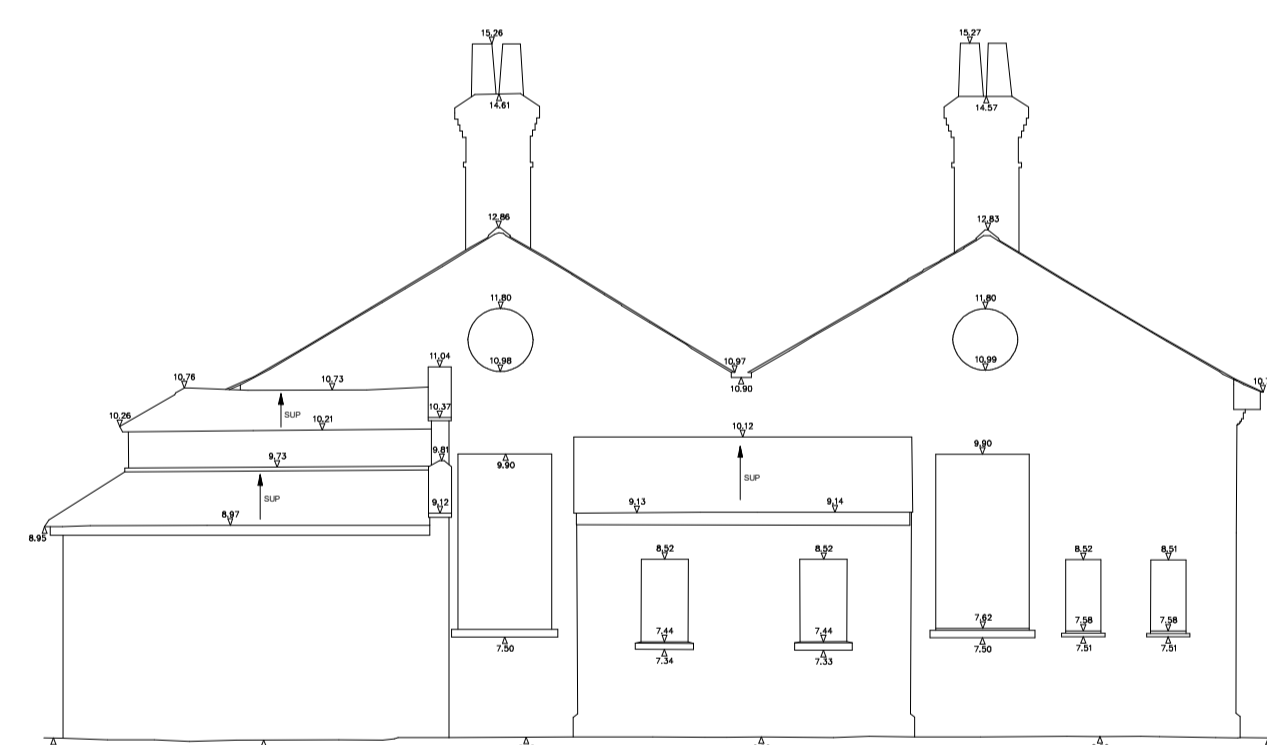

DATUM 3.00m

ELEVATION 26

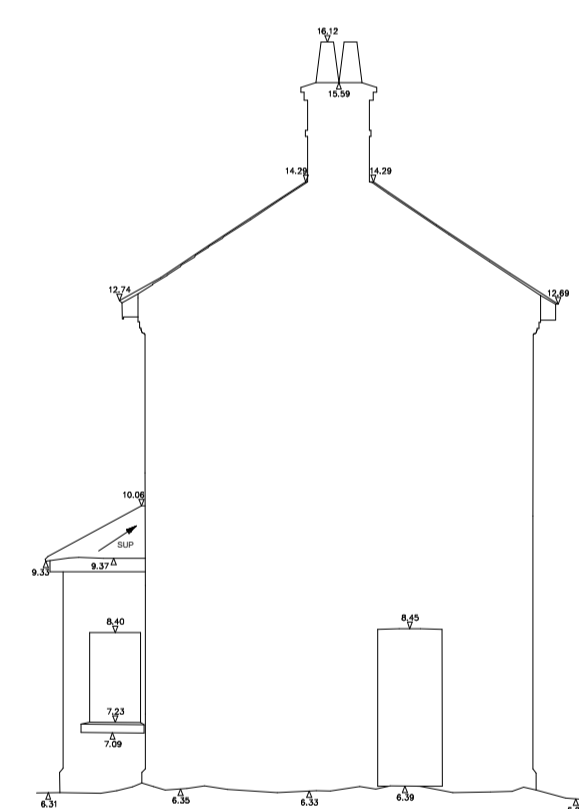

DATUM 3.00m

ELEVATION 27

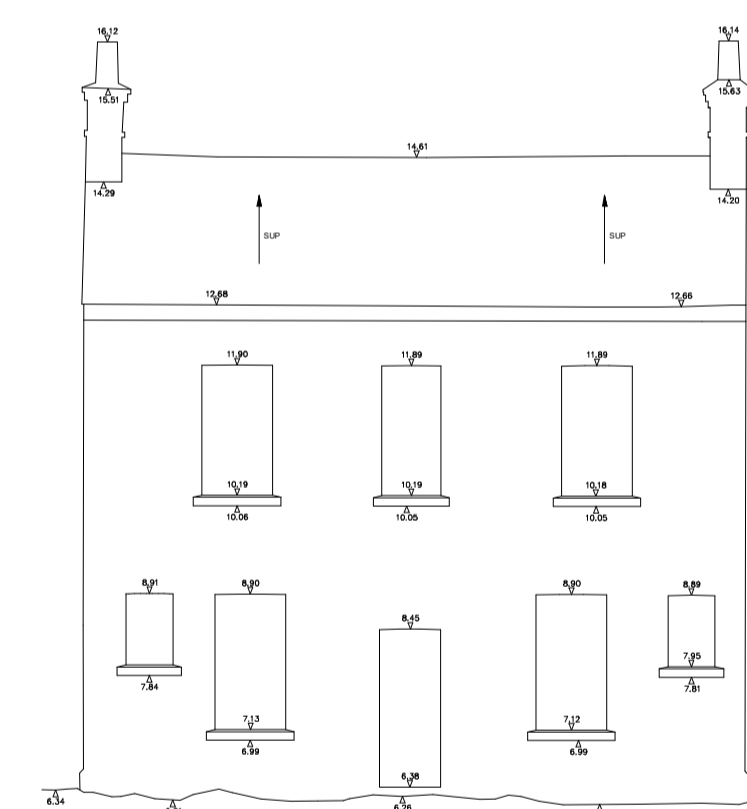

DATUM 3.00m

ELEVATION 28

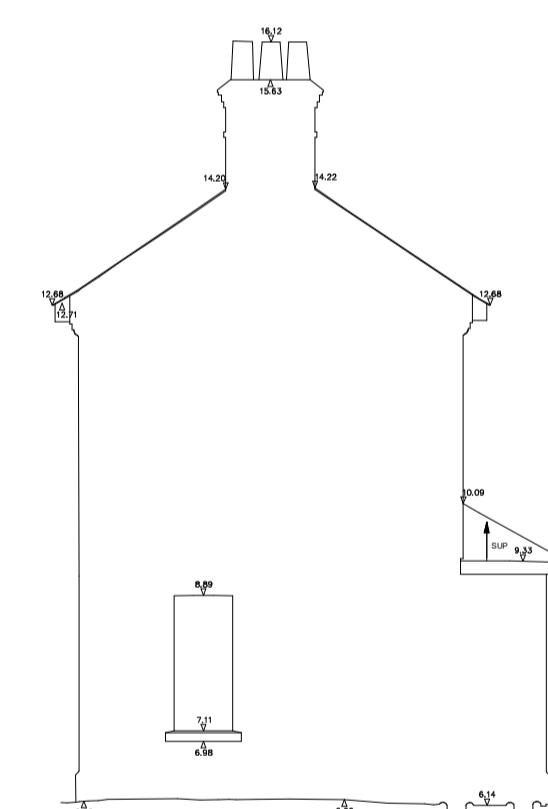

DATUM 3.00m

ELEVATION 29

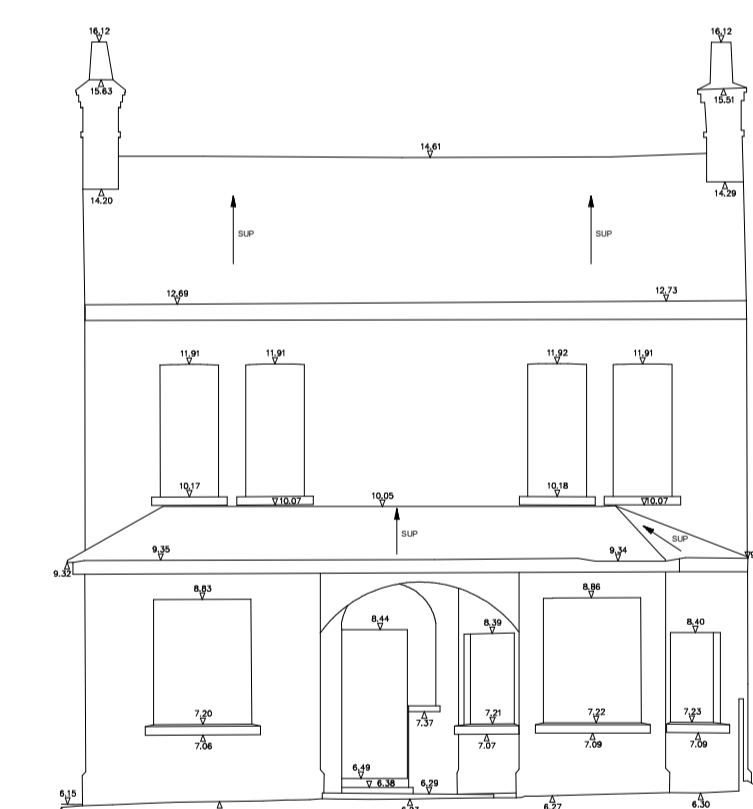

DATUM 3.00m

ELEVATION 30

Revision	Description	Date	Drawn	Checked
1	For Information	20/08/2021	FS	OM

SCOTT BROWNRIGG

77 Endell Street
London WC2H 9DZ
T +44 (0)20 7240 7766
W scottbrownrigg.com

Clients Name
Star Land Realty UK Ltd.

Job Title
Barnes Hospital Site

Drawing Title
Existing Buildings - Elevations 8

Scale
1 : 100 @A1

SBR Project No.
18387

SBR Project No. Originator Volume Level Type Role Number
18387-SBR-ZZ-XX-DR-A-81308

Subsidiary Code Status Rev
S4 - FOR STAGE APPROVAL 1