



Greggs Bakery / Twickenham

External Lighting Assessment

Prepared by Desco

05 August 2022



LONDON SQUARE DEVELOPMENTS LTD

**FORMER GREGGS BAKERY SITE
TWICKENHAM
TW2 6RT**

**Exterior Lighting Assessment
Industrial-Led Scheme**

Desco (Design & Consultancy) Ltd

AMP House
Dingwall Road
Croydon
CR0 2LX

Telephone: 020 8686 5583

Issue No.: 03

Date: July 2022

Ref: 1823-63-RPT-03

Author: DH

Checked/Authorised: SB

SCHEDULE OF REVISIONS

Revision	Date	Changes	Author	Checked
01	04/03/2021	DRAFT FOR COMMENT	DH	SB
02	05/04/2022	UPDATED PLANNING SUBMISSION	DH	SB
03	13/07/2022	UPDATED TO INCLUDE AFFORDABLE WORKSHOP UNIT	DH	SB



INDEX

1.0 INTRODUCTION3

2.0 LIGHTING DESIGN4

3.0 LUMINAIRE PARTS LIST 11

4.0 CALCULATION SURFACES..... 12

5.0 3D RENDERING 16

6.0 LIGHTING DATASHEETS 18

7.0 CONCLUSION 23

8.0 APPENDIX A – PHASE 1 LIGHTING LAYOUT..... 24

1.0 INTRODUCTION

This report outlines the preliminary external lighting design for the proposed residential AND industrial development at the former Greggs Bakery site in Twickenham. The project comprises of the Demolition of existing buildings (with retention of a single dwelling) and redevelopment of the site to provide 97 residential units and 883 sqm industrial floorspace (Use Class E(g)(iii)) and 117sqm of affordable workspace (Use Class E) with associated hard and soft landscaping, car parking and highways works and other associated works

The existing Site comprises the former Greggs Bakery Site in Twickenham and no.2 Gould Road, within the London Borough of Richmond Upon Thames. The Site is L shaped and is bound by the River Crane to the north and railway line beyond, residential properties on Norcutt Road to the east, Edwin Road to the south, residential properties on Crane Road to the west and further residential properties on Crane Road/ Gould Road and at Crane Mews to the northwest.

2.0 LIGHTING DESIGN

The external lighting design needs to satisfy various design criteria set out by professional bodies as detailed below.

The design will comply with the Society of Light and Lighting's CIBSE LG6: The Outdoor Environment (2016). The class of lighting proposed for the development has been selected as E3 for 'small town centres or suburban locations' as outlined within Table 2.1 below, extracted by CIBSE from CIE 150 : 2003 (Guide on the Limitation of the Effects of Obtrusive Light from Outdoor Lighting Installations) and used in section 2.1.10 of LG6.

In this section of LG6, the document states that the local context should be considered when designing the lighting so that the building does not appear visually out of keeping with its immediate surroundings; E0 being protected areas such as a dark sky park where no lighting is permitted, and E3 (our selection) being suburban areas with medium district brightness.

Table 2.1 Environmental zones

Zone	Surroundings	Lighting environment	Examples
E0	Protected	Dark	IDA Dark Sky Parks, UNESCO Starlight Reserves
E1	Natural	Intrinsically dark	Areas of Outstanding Natural Beauty, relatively uninhabited rural areas
E2	Rural	Low district brightness	Village or relatively dark outer suburban locations
E3	Suburban	Medium district brightness	Small town centres or suburban locations
E4	Urban	High district brightness	Town and city centres, commercial areas

Source: CIE 150: 2003.

When designing in an E3 classification area the designer must ensure that upwards light is no greater than 15% (Upward Light Ratio – ULR) as stated in table 6.3, chapter 6 of the Society of Light and Lighting handbook.

Environmental zone	Maximum upward light output ratio (%)
E1	0
E2	5
E3	15
E4	25

The referenced E3 environmental zone is outlined in the Institution of Lighting Engineers Guidance Notes for the Reduction of Obtrusive Light GN01:2011, shown below:

Environmental Zone	Sky Glow ULR [Max %] ⁽¹⁾	Light Intrusion (into Windows) E _v [lux] ⁽²⁾		Luminaire Intensity I [candelas] ⁽³⁾		Building Luminance Pre-curfew ⁽⁴⁾
		Pre-curfew	Post-curfew	Pre-curfew	Post-curfew	Average, L [cd/m ²]
E0	0	0	0	0	0	0
E1	0	2	0 (1*)	2,500	0	0
E2	2.5	5	1	7,500	500	5
E3	5.0	10	2	10,000	1,000	10
E4	15	25	5	25,000	2,500	25

ULR = **Upward Light Ratio of the Installation** is the maximum permitted percentage of luminaire flux that goes directly into the sky.

E_v = **Vertical Illuminance in Lux** - measured flat on the glazing at the centre of the window.

I = **Light Intensity in Candelas (cd)**

L = **Luminance in Candelas per Square Metre (cd/m²)**

Curfew = **the time after which stricter requirements (for the control of obtrusive light) will apply**; often a condition of use of lighting applied by the local planning authority. If not otherwise stated - 23.00hrs is suggested.

* = **Permitted only from** Public road lighting installations

The road lighting illuminance will comply with the levels outlined in BS5489-1:2013 Code of practice for the design of road lighting, lighting of roads and public amenity areas. Table A.6 (below) provides lighting classes for subsidiary roads with mainly slow moving vehicles, cyclists and pedestrians. As this is a residential site, a quite traffic flow has been selected which relates to a P6 lighting class.

Table A.6 Lighting classes for subsidiary roads with mainly slow-moving vehicles, cyclists and pedestrians

Traffic flow	Lighting class	
	Ambient luminance: very low (E1) or low (E2)	Ambient luminance: moderate (E3) or high (E4)
Busy ^{A)}	S4 or P4	S4 or P4
Normal ^{B)}	S5 or P5	S5 or P5
Quiet ^{C)}	S6 or P6	S6 or P6

NOTE 1 If facial recognition is important then an ES lighting class from BS EN 13201-2:2003, Table 5, or an E_{sc} lighting class from CIE 115:2010 [N1], Table 7, can be selected as an additional criterion. Good colour rendering contributes to a better facial recognition. (The ES lighting class in BS EN 13201-2:2003 is expected to be replaced by SC upon publication of the revised edition.)

NOTE 2 To ensure adequate uniformity, the actual value of the maintained average illuminance is not to exceed 1.5 times the value indicated for the class.

NOTE 3 It is recommended that the actual overall uniformity of illuminance U_o be as high as reasonably practicable.

NOTE 4 Grey highlighting indicates situations that would not usually occur in the UK.

NOTE 5 The ambient luminance descriptions E1 to E4 refer to the environmental zone as defined in ILP GN01 [N5].

^{A)} Busy traffic flow refers to areas where the traffic usage is high and can be associated with local amenities such as clubs, shopping facilities, public houses, etc.

^{B)} Normal traffic flow refers to areas where the traffic usage is of a level equivalent to a housing estate access road.

^{C)} Quiet traffic flow refers to areas where the traffic usage is of a level equivalent to a residential road and mainly associated with the adjacent properties or properties on other equivalent roads accessed from this road.

The referenced P6 lighting class is outlined in BS EN 13201-2:2015 Table 3 below and will achieve a minimum maintained average illuminance within road and pathway areas of 2 lux and a minimum level of 0.4 lux.

Table 3 — P lighting classes

Class	Horizontal illuminance		Additional requirement if facial recognition is necessary	
	\bar{E}^a [minimum maintained] lx	E_{min} [maintained] lx	$E_{v,min}$ [maintained] lx	$E_{sc,min}$ [maintained] lx
P1	15,0	3,00	5,0	5,0
P2	10,0	2,00	3,0	2,0
P3	7,50	1,50	2,5	1,5
P4	5,00	1,00	1,5	1,0
P5	3,00	0,60	1,0	0,6
P6	2,00	0,40	0,6	0,2
P7	performance not determined	performance not determined		

^a To provide for uniformity, the actual value of the maintained average illuminance shall not exceed 1,5 times the minimum \bar{E} value indicated for the class.

NOTE 4 A high colour rendering contributes to a better facial recognition.

The lighting design for the car park areas is based on a light traffic level and will achieve a minimum maintained average illuminance of 5 lux and a minimum uniformity of 0.25 lux as defined in Table 5 of BS 5489-1:2013.

Table 5 **Maintained lighting levels for outdoor car parks**

Type of area and usage	\bar{E} lx	U_o
Light traffic, e.g. parking areas of shops, terraced and apartment houses; cycle parks	5	0.25
Medium traffic, e.g. parking areas of department stores, office buildings, plants, sports and multipurpose building complexes	10	0.25
Heavy traffic, e.g. parking areas of schools, churches, major sports and multipurpose sports and building complexes	20	0.25

The lighting layout has been modelled using Dialux lighting design software to ensure that the above criteria are adhered to.

The proposed design will generally comprise luminaires mounted on 4m columns throughout, supplemented with wall mounted bulkheads at the exit/entrance routes from the buildings.

Area	Description	Fittings Used
Main Vehicle Roadways	Roadways illuminated to an average of 2 lux and maintain a minimum of 0.4 lux.	31W LED luminaire mounted on 4 metre columns complete with optics specific for use on roadways. Elongated light distribution to improve uniformity. Colour rendering index is 70+ for good facial recognition.
Car Parks	Car parks illuminated to 5 lux with a uniformity of 0.25.	A combination of 15W LED wall mounted bulkheads and 24W LED bollard luminaires are proposed to minimise the impact on the nocturnal wildlife. Refer to Report: Ref. 1823-63-RPT-02 'Supplementary Minimising the Impact of Lighting on Nocturnal Wildlife'
Footpaths	Footpaths illuminated to an average of 2 lux and maintain a minimum of 0.4 lux.	A combination of 15W LED wall mounted bulkheads and 24W LED bollard luminaires are proposed to minimise the impact on the nocturnal wildlife. Refer to Report: Ref. 1823-63-RPT-02 'Supplementary Minimising the Impact of Lighting on Nocturnal Wildlife'

 <p><i>THORLUX STARBEAM</i></p>	<p>LED floodlight luminaires mounted on 4 meter columns will be located along roadways.</p> <p>Each fitting comprises a die cast aluminium housing, polycarbonate cover and high efficiency 31W LED 4000k lamp source.</p> <p>Specific optics designed for use in car parks and roadways ensure that minimum lighting levels can be achieved using a reduced number of fittings.</p>
 <p><i>DW Windsor Pharola DS</i></p>	<p>1 meter tall LED bollard luminaire positioned on the perimeter of car parks and footpaths.</p> <p>Each fitting will comprise an aluminium housing finished in black, complete with integral diffuser to direct the light in a downward direction, thus minimising the impact on the local nocturnal wildlife.</p>
 <p><i>DEXTRA AMEX LED</i></p>	<p>Wall mounted circular bulkhead luminaire positioned at low level along the Northern wall of the site adjacent to river Crane.</p> <p>Each fitting will comprise IP65 die-cast aluminium housing and eyelid cover to minimise upward light spill.</p>

Biodiversity Design Considerations

As part of the design process, the impact of external lighting on the local biodiversity has been considered, in particular to bats which currently commute across and forage over the site. In order to minimise any disturbance to the local bat population (and other nocturnal wildlife), the proposed lighting scheme shall incorporate the following measures:

- The use of mercury or metal halide lamps which emit high levels of UV have been avoided. External luminaires comprise LED lamps which produce light with a wavelength of 590nm to minimise disturbance to bats. Also, the LED lamps produce no UV emissions which ensures insects are not attracted away from neighbouring habitats.
- The proposed luminaires comprise integral reflectors which control the direction and spread of the light so that only the immediate area is illuminated. The design of the light fittings ensures minimum upward light spill as detailed in section 2.0 LIGHTING DESIGN of this report.
- Illuminance between lighting columns generally drops below 1 lux. These lower lighting levels will encourage bats to fly between columns and prevent the formation of a 'light barrier' which can be detrimental to some species of bat.
- The luminaires shall comprise louvres and diffusers which reflect/direct light to the required areas, thus avoiding unnecessary light spillage and upward light pollution.
- The external lighting has been modelled using lighting design software, the calculation outputs of which are enclosed within this report. This has enabled lighting levels and spill across the space to be accurately predicted, thus ensuring that light is not provided to areas which do not require illumination.
- There is no proposed uplighting to trees and other landscape features, both new and existing, which will avoid illuminating bat foraging and commuting habitats, as well as any bat boxes installed on retained trees.
- Refer to report Ref: 1823-63-RPT-02 'Supplementary Report: Minimising the Impact of Lighting on Nocturnal Wildlife' for further details on the lighting design to mitigate impact on nocturnal wildlife.

3.0 LUMINAIRE PARTS LIST

17 Pieces	<p>Dedra Group AMEX L16 E CB4 AMEX LED Article No: -AMEX L16 E CB4 Luminous flux (Luminaire): 759 lm Luminous flux (Lamps): 1600 lm Luminaire Wattage: 15.2 W Luminaire classification according to CIE: S7 CIE flux code: 16 42 71 57 47 Fitting: 2 x STARK LLE-G3-24-140-650-840-CLA 28000392 (Correction Factor 1.000)</p>		
5 Pieces	<p>Thorlux PRB17522 PROBE XL LED Article No: PRB17522 Luminous flux (Luminaire): 1044 lm Luminous flux (Lamps): 1040 lm Luminaire Wattage: 28.0 W Luminaire classification according to CIE: 78 CIE flux code: 12 45 82 78 100 Fitting: 1 x 24W LED (Correction Factor 1.000)</p>		
2 Pieces	<p>PHAROLA BOLLARD, DARK SKIES Lamp type: LED Nominal lamp power: 26 W Total flux: 1408 lm Luminous efficacy: 54 lm/W CCT: 3783 K CRI: 84 LOR: 100% Total power: 26 W</p>		
6 Pieces	<p>Thorlux SB17561 STARBEAM LED ROADWAY Article No: SB17561 Luminous flux (Luminaire): 3790 lm Luminous flux (Lamps): 3750 lm Luminaire Wattage: 33.0 W Luminaire classification according to CIE: 99 CIE flux code: 42 76 57 99 100 Fitting: 1 x 31W LED (Correction Factor 1.000)</p>		

4.0 CALCULATION SURFACES

Main Roadway

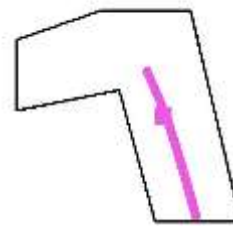
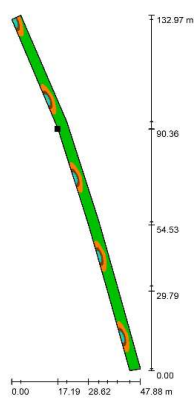

E_{av} [lx]
15

E_{min} [lx]
1.02

E_{max} [lx]
88

u_0
0.067

North West Car Park

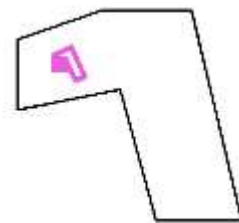
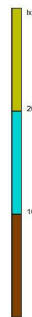
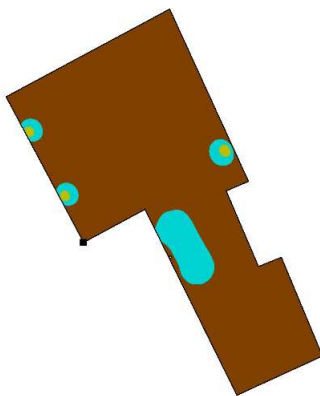

E_{av} [lx]
8.13

E_{min} [lx]
0.65

E_{max} [lx]
56

u_0
0.080

North Car Park

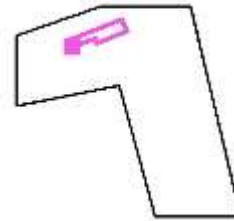
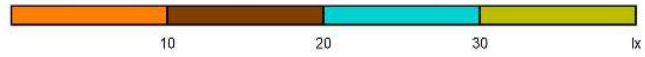
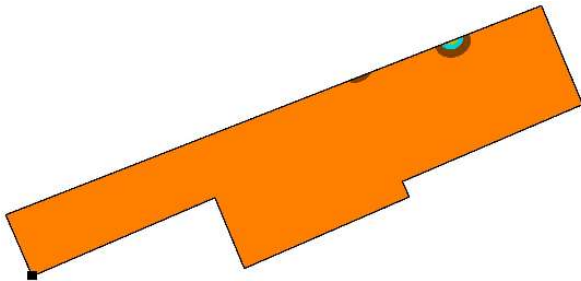

E_{av} [lx]
3.27

E_{min} [lx]
0.92

E_{max} [lx]
40

u0
0.283

North East Car Park

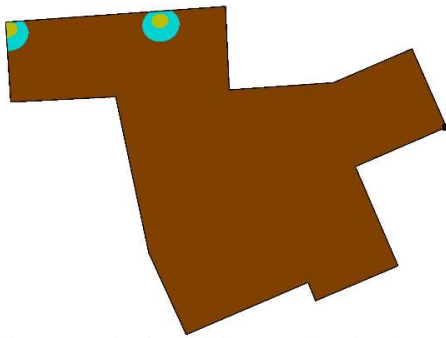

E_{av} [lx]
4.02

E_{min} [lx]
0.64

E_{max} [lx]
53

u0
0.158

North East Car Park 2

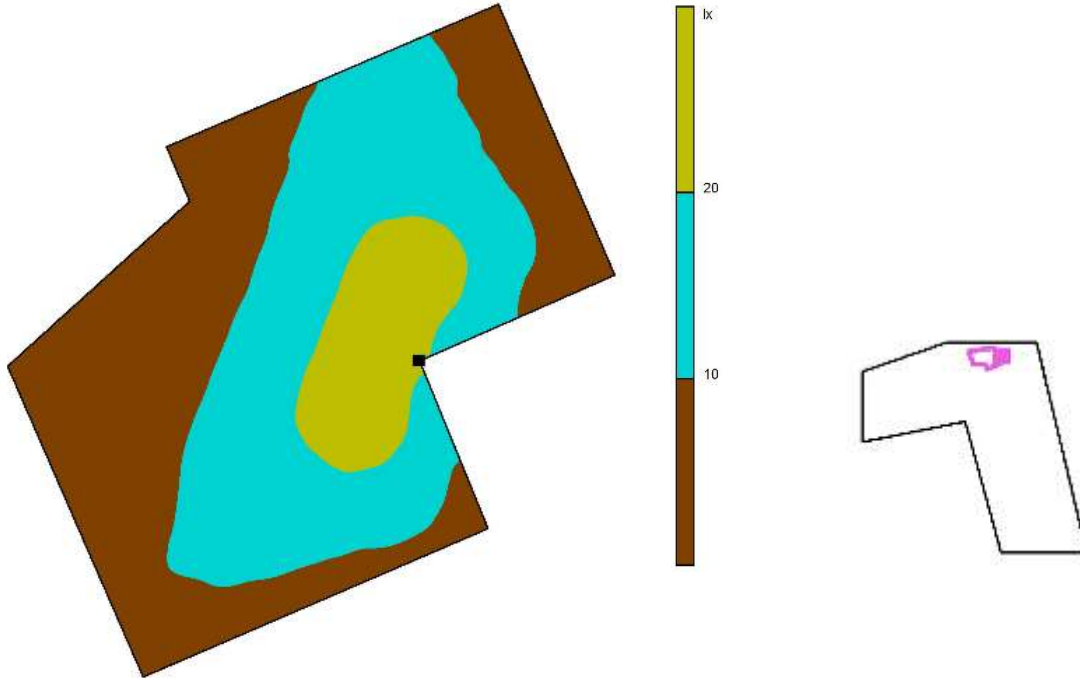

E_{av} [lx]
12

E_{min} [lx]
1.63

E_{max} [lx]
28

$u0$
0.139

Industrial Unit

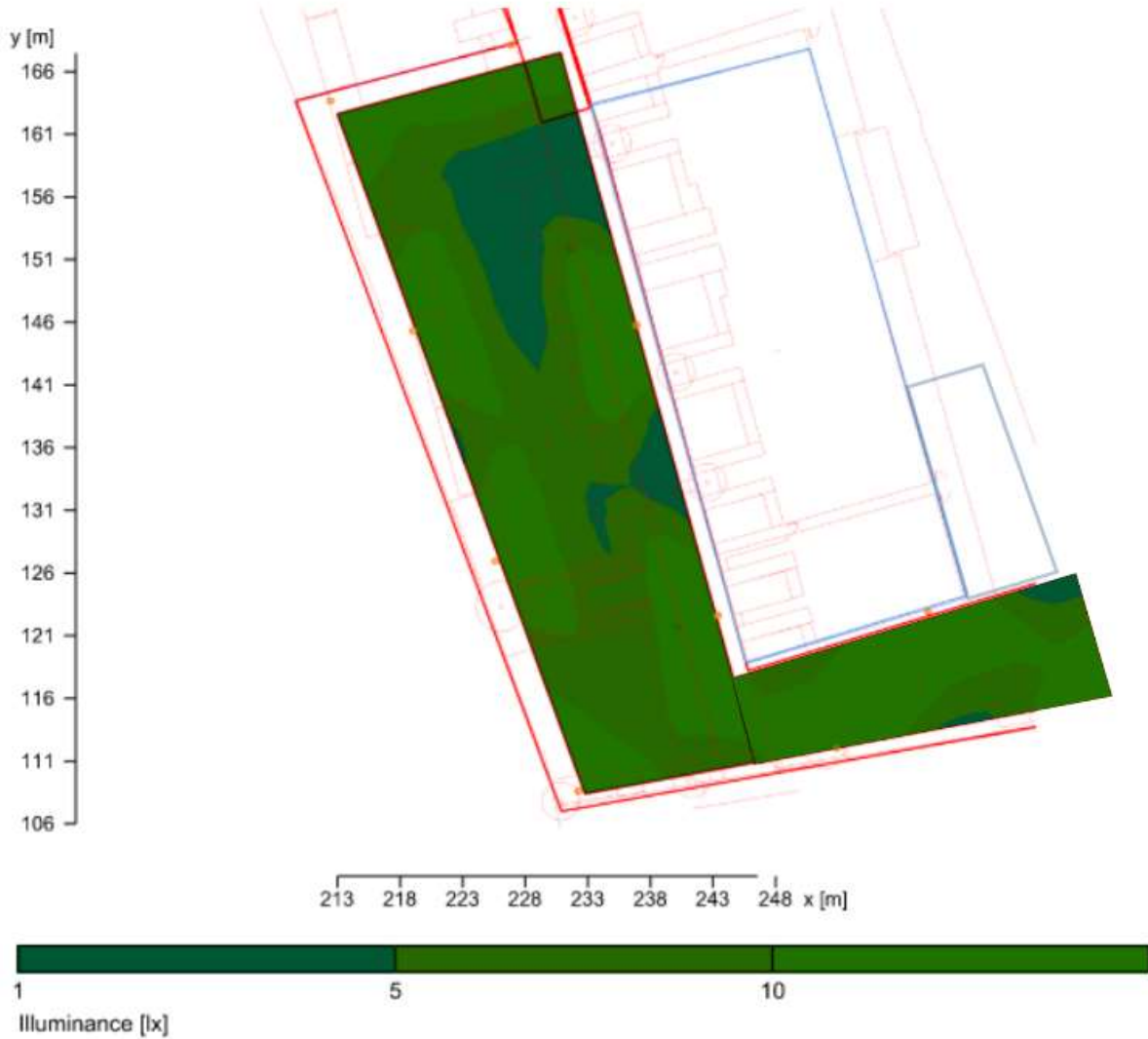

5.0 3D RENDERING

View Looking South West



View Looking South



View Looking North



Industrial Unit South

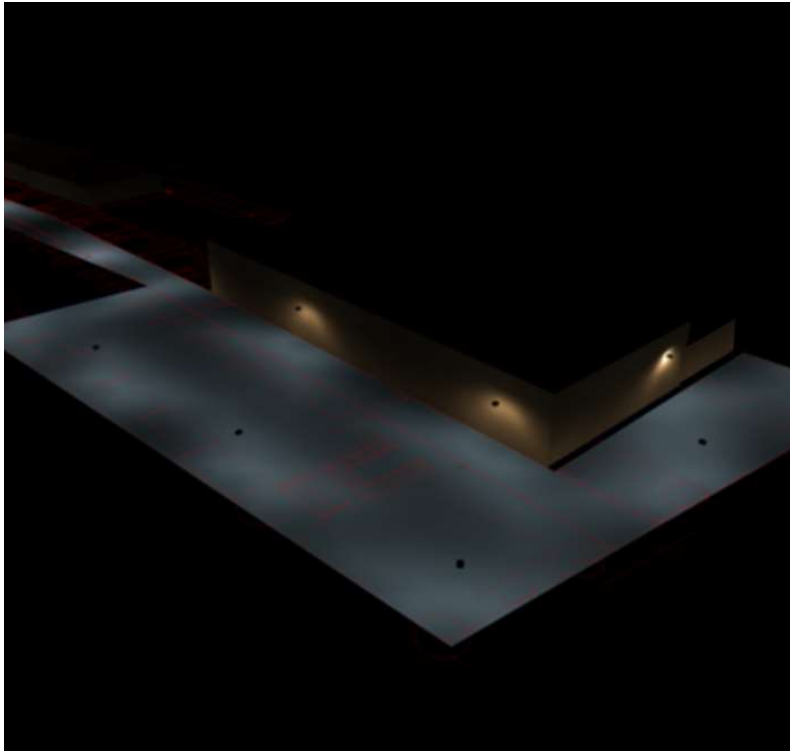

6.0 LIGHTING DATASHEETS

Thorlux Starbeam Area and Roadway



RANGE

	LED	AREA DISTRIBUTION	ROADWAY DISTRIBUTION	APPROX. kg	
STANDARD	Small Version				
		31W - 4000K	SB 17553L	SB 17561L	8.0
		62W - 4000K	SB 17554L	SB 17562L	8.0
		31W - 5700K	SB 15800L	SB 15801L	8.0
		62W - 5700K	SB 15802L	SB 15803L	8.0
	Large Version				
		88W - 4000K	SB 17555L	SB 17563L	9.2
		123W - 4000K	SB 17556L	SB 17564L	9.2
		161W - 4000K	SB 18350L	SB 18351L	9.2
		88W - 5700K	SB 15804L	SB 15805L	9.2
		123W - 5700K	SB 15806L	SB 15807L	9.2
		161W - 5700K	SB 18362L	SB 18363L	9.2

LED AREA FLOODLIGHTS AND STREET LIGHTS

IP66 IK10 CE LED

WINDAGE - small: 0.06m² large: 0.07m²

SPECIFICATION

- Die-cast aluminium body and gear compartment finished polyester silver RAL9006
- Die-cast aluminium, fast release gear compartment lid finished polyester graphite
- Polycarbonate cover and acrylic high efficiency LED lenses
- Area or roadway optical distributions
- Integral high efficiency driver
- Extremely efficient and long system life up to 100,000 hours
- Suitable for ambient temperatures up to 50°C
- Smart External versions with intelligent lighting control for use up to 12 metres mounting height
- SmartScan wireless technology removes the need for control cabling. Ideal for retro-fit
- Pole top 76mm as standard, adjustable through 90°
- Wall mounting bracket accessory
- Wide range of mounting options (see page 5 for details)
- Photocell option
- Fitted with 4000K or 5700K LEDs

DIMENSIONS

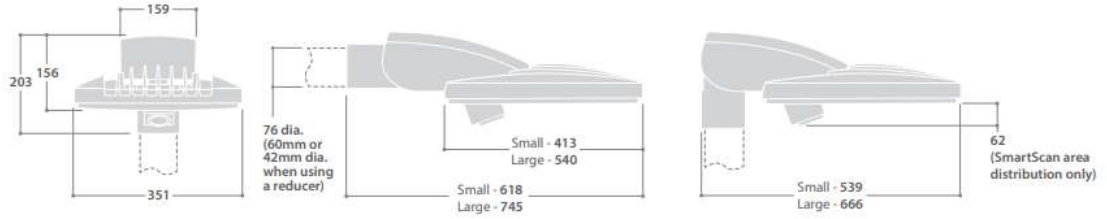

PHOTOMETRIC GUIDE

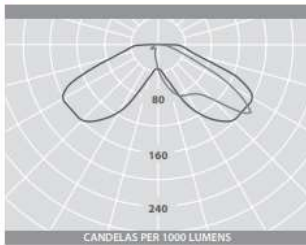

AREA DISTRIBUTION

Luminaire Lumen Output:
 31W = 3500lm
 62W = 6750lm
 88W = 10150lm
 123W = 13550lm
 161W = 17250lm

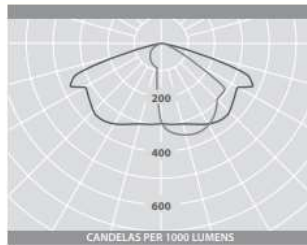

ROADWAY DISTRIBUTION

Luminaire Lumen Output:
 31W = 3700lm
 62W = 7100lm
 88W = 10700lm
 123W = 14250lm
 161W = 18150lm

DW Windsor Pharola DS



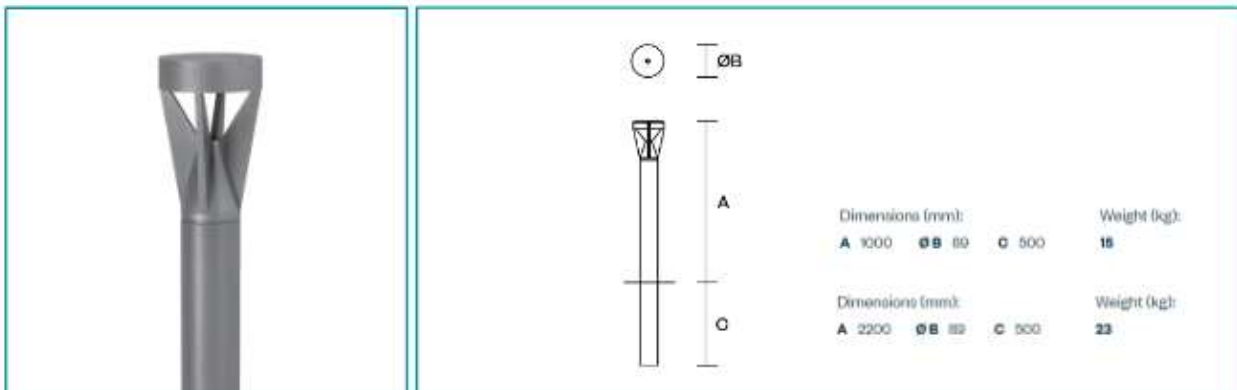

Sample Specification Text

Pharola DS 1000mm bollard. 9 LED light engine with outputs up to 1,730lm with a 3,000K colour temperature and symmetric or asymmetric light distribution. Dark Sky-friendly with 0% ULOR. Die-cast aluminium head with polycarbonate glazing and galvanised steel body. IP66 and IK10 protection. 100,000 hour (L80) lifetime. For -20°C to +50°C ambient operating temperatures. Class I.

Performance

Output (luminaire flux)	1,730lm (max)
Power	20W (max)
Efficacy	87lm/W (max)
Number of LEDs	9
Colour Temperatures	3,000K 4,000K
Colour Rendering Index (CRI)	70 / 80
Distributions	Symmetric (180° backshield on request)
Certifications	UKCA, CE

Mechanical

Mounting Options	Root mounted / Flange plate / 1 st Fix root
Glazing	Polycarbonate
Housing	Galvanised steel (body) Die-cast aluminium (head)
Colours	White RAL 9016 Black RAL 9005 Aluminium RAL 9006 Metallic Grey 9007 Metallic Dark Grey DB703 (other RAL colours on request)
Finish	Polyester powder coat
IP Rating	IP66
IK Rating	IK10
Weight	15kg (Pharola DS 1000) 23kg (Pharola DS 2200)

Electrical

Driver Options	DALI
Drive Current	700mA
Operating Voltage	220-240V
Electrical Class	Class I / Class II
Operating Temperature Limit	-20°C to +40°C
Rated Lifetime	100,000 hours (L70)

Controls

Control Options	Remote switch
------------------------	---------------

Dextra Amex LED



SPECIFICATION

Construction

- Die cast aluminium housing.
- Supplied with Eyelid cover

Performance

- Up to 99 luminaire lumens per circuit watt.
- Philips Lumileds LM80 verified: 90% LED lumen maintenance at 60,000 operating hours.
- Standard Deviation Colour Match – 3 Step Macadam's Ellipse.

Control

- Available with Switch dimming, DALI dimming, HFR 1-10v Analogue dimming and Digital dimming.
- Integral microwave sensor option.

Emergency

- Available with standard, self test and autotest dimming.

Installation

- Suitable for rear cable entry only.

7.0 CONCLUSION

The results obtained from the Dialux lighting calculations indicate that the illuminance and uniformity criteria set out in section 2.0 of this report are achieved using the luminaires and lighting layout proposed. The exception to this is the car park area to the North of the site adjacent to the river, where low level lighting has been employed to reduce impact on nocturnal wildlife in line with the Ecologist's recommendations. For further details refer to separate report Ref: 1823-63-RPT-02 'Supplementary Report: Minimising the Impact of Lighting on Nocturnal Wildlife'

The calculations also show that upward light spill has been kept to a minimum thanks to the optics integral to each luminaire which direct the light downwards to the areas requiring illumination. This, together with the use of modern high efficiency LED lamps will reduce the impact of the lighting installation on local biodiversity in the area.

See Appendix A for the overall lighting layout.



8.0 APPENDIX A – PHASE 1 LIGHTING LAYOUT



Original drawing size A1
Original line length 35mm

THIS DRAWING HAS BEEN DEVELOPED FROM THE FOLLOWING DESIGN DRAWINGS:
ASSAEL ARCHITECTURE LIMITED
GREGGS BAKERY
Proposed Ground Floor Landscape General Arrangement
DRAWING No. A394 1000 Rev - P2
DWG RECEIVED 25th October 2019

THIS DRAWING REFERS TO THE FOLLOWING XREF FILES:
XB_Shadows

NOTES

1. THIS DRAWING TO BE READ IN CONJUNCTION WITH:
THE PROJECT SPECIFIC PMR SPECIFICATIONS
THE PROJECT SPECIFIC DESIGNERS RISK ASSESSMENTS.

- LEGEND:**
- X1 THERLUX 'STARBEAM' 3W 400K LED LUMINAIRE C/W ROADWAY LIGHT DISTRIBUTION MOUNTED ON 4M COLUMN
 - X2 THERLUX 'STARBEAM' 3W 400K LED LUMINAIRE C/W AREA LIGHT DISTRIBUTION MOUNTED ON 4M COLUMN
 - B1 DEKTRA LIGHTING 'AMENITY' EXTERIOR LED 'CW WALL MOUNTED LUMINAIRE
 - A1 DW WINDSOR PHAROLA DARK SCREENS 2600 3763 K BOLLARDO LUMINAIRE



X1 & X2



B1



A1

REV	DATE	BY	DESCRIPTION	CHK/APP
01	25.10.2019	PH	FOR PLANNING	PH

desco
desco (design & consultancy) ltd
AMP House, 6th Floor
Dringwell Road
East Croydon, CR0 2LX
Tel: 0208 6865583
E-Mail: drawings@desco.uk.com

DRAWING NO	SCALE	SHEET
1823-S-63-LAY-03	1:250	A0

PROJECT: LONDON SQUARE

ARCHITECT: ASSAEL

PROJECT: GREGGS BAKERY SITE TWICKENHAM

SERVICE: ELECTRICAL SERVICES EXTERNAL LIGHTING LAYOUT

DRAWING NO	REV
1823-S-63-LAY-03	01