

Note:

1. Window to be glazed with clear 4/8/6.8 lam. acoustic glass, low E, krypton filled double glazed units with **white** spacer bars (toughened where indicated);
2. All timber to be Hardwood Frame/Accoya sashes/Hardwood cill;
3. Window to be fully weather stripped with soft compression seals;
4. Ironmongery - as shown in antique black finish;
5. Colour to be:
 - 5.1. **Frame and sashes IN & OUT - to match RAL 9016 Traffic white, 30% sheen;**

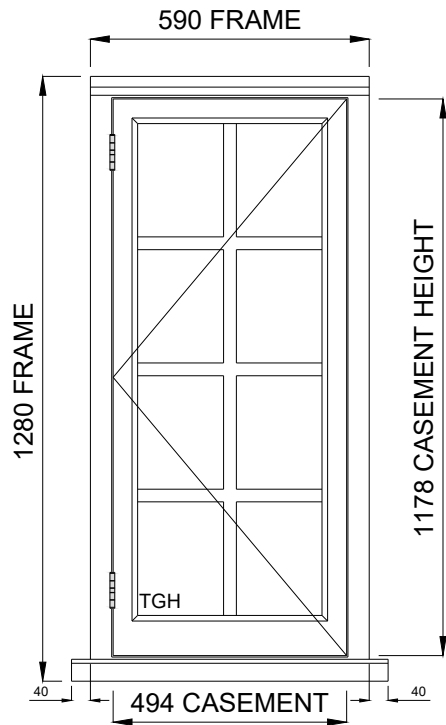

W3
1st fl - Front Elev. Landing
Qty 1
 Viewed from outside
 Open outwards

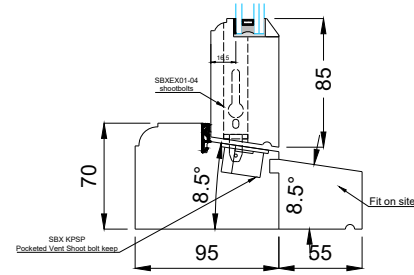
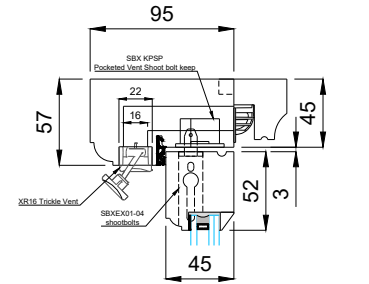
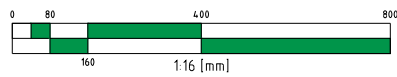

Vertical section

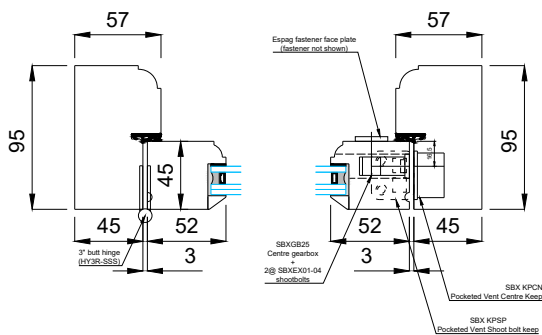
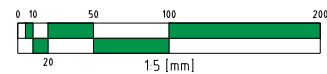

Horizontal section

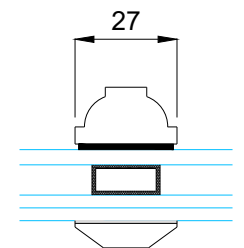
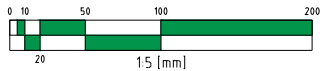

Glazing bar detail

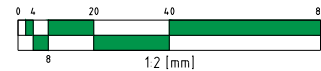

Reddiseals.com
 Monkeytail stay 12"
 CMK105BL
 Antique Black Finish



Reddiseals.com
 Monkeytail espag fastener
 CMK610RBL
 Antique Black Finish



www.coastal-group.com
 Butt hinge 3"
 HY3R-SSS
 Stainless steel Finish

Scale	ALL@A3	Drawing No.	I1018_3
Date	28/06/24	Rev/Issue	0
Dimension	mm	Drawn by	MT

**I1081 - 82 Cambridge Road Teddington
 TW11 8DN**
 Proposed sections & details to casement
 window



Timbawood Ltd,
 Unit 9, Mount Road Ind. Est. Feltham, TW13 6AR
 Tel: 0800 043 2499 Fax: 0208 867 2767
 email: mail@timbawood.co.uk web: www.timbawood.co.uk