

Note:

1. Window to be glazed with sandblasted 4/8/6.8 lam. acoustic glass, low E, krypton filled double glazed units with **white** spacer bars (toughened where indicated);
2. All timber to be Hardwood Frame/Accoya sashes/Hardwood cill;
3. Window to be fully weather stripped with soft compression seals;
4. Ironmongery - as shown in antique black finish;
5. Colour to be:
  - 5.1. **Frame and sashes IN & OUT - to match RAL 9016 Traffic white, 30% sheen;**

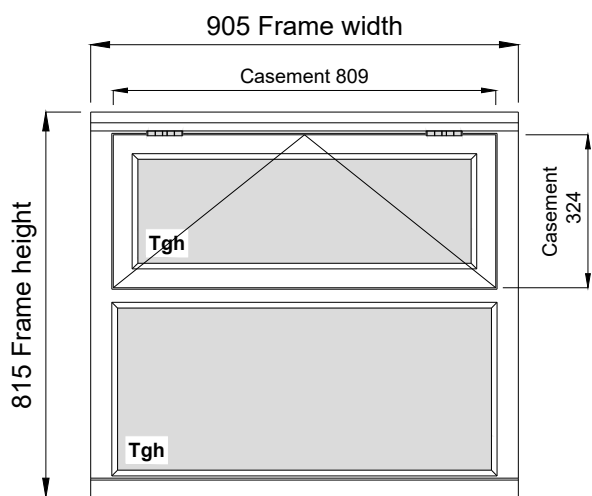

**W.10**  
**GFL - Side Elev. - Boiler Room**  
**Qty 1**  
 Viewed from outside  
 Open outwards

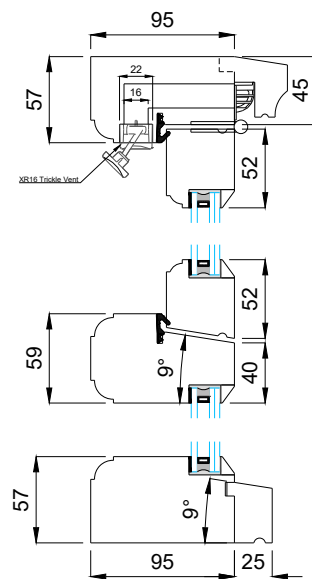
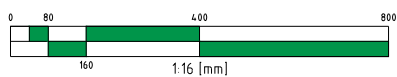

Vertical section

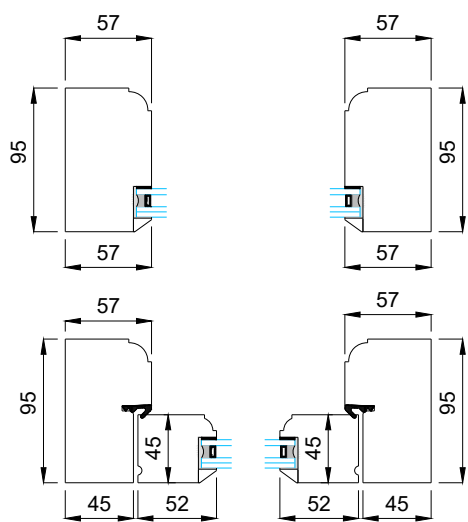
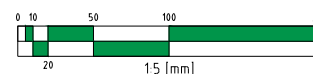

Direct-glazed section

Top-hung section

Horizontal section

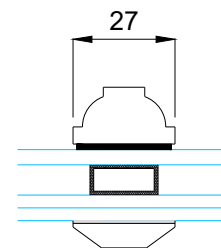
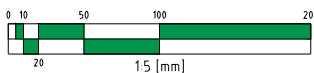

Glazing bar detail

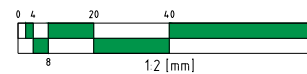

Reddiseals.com  
 Monkeytail stay 12"  
 CMK105BL  
 Antique Black Finish



Reddiseals.com  
 Locking pivot  
 CA101BL  
 Black Finish



www.coastal-group.com  
 Butt hinge 3"  
 HY3R-SSS  
 Stainless steel Finish

Scale	ALL@A3	Drawing No.	I1018_10
Date	28/06/24	Rev/Issue	0
Dimension	mm	Drawn by	MT

**I1081 - 82 Cambridge Road Teddington  
 TW11 8DN**  
 Proposed sections & details to casement  
 window



Timbawood Ltd.  
 Unit 9, Mount Road Ind. Est. Feltham, TW13 6AR  
 Tel: 0800 043 2499 Fax: 0208 867 2767  
 email: mail@timbawood.co.uk web: www.timbawood.co.uk