

01 PROPOSED FASCIA SIGN A -HALO ILLUMINATED- ILLUMINATION LEVEL - 375 cd/m²
1:50@A3

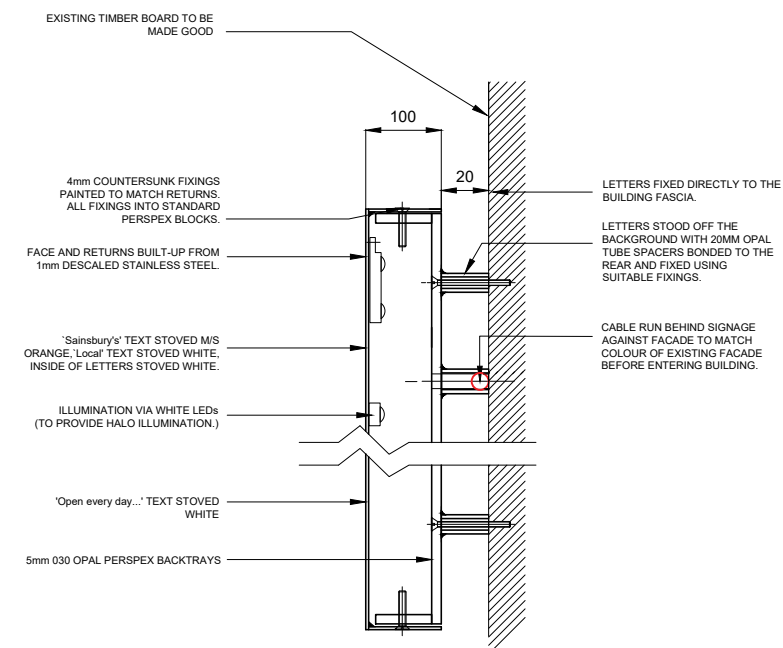

02 PROPOSED FASCIA SIGNAGE DETAILS -HALO ILLUMINATED- ILLUMINATION LEVEL - 375 cd/m²
1:10@A3

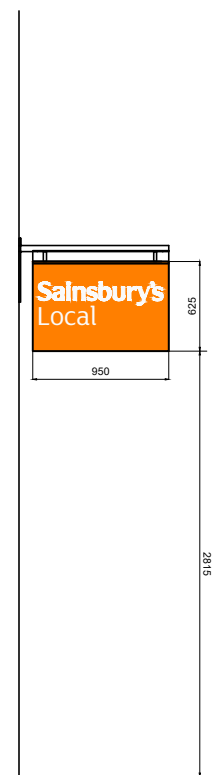

03 PROJECTING SIGN
1:50@A3
ILLUMINATION LEVEL - 204 cd/m²

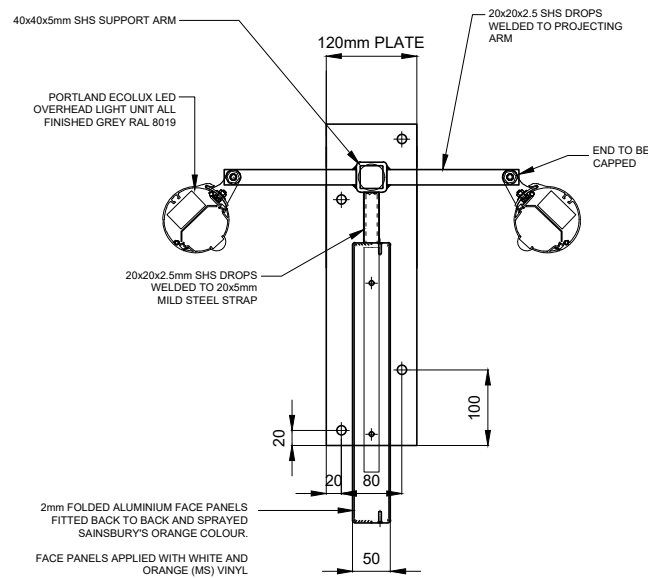

04 PROJECTING SIGN DETAIL
1:10@A3

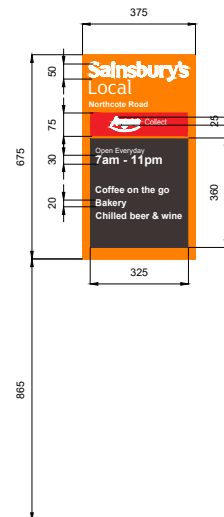

05 WELCOME MESSAGE
1:25@A3

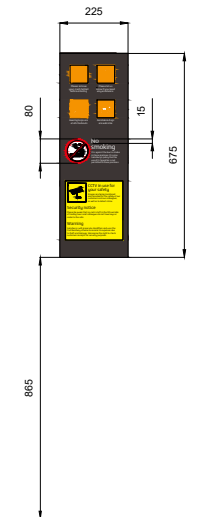

06 STAT SIGN
1:25@A3

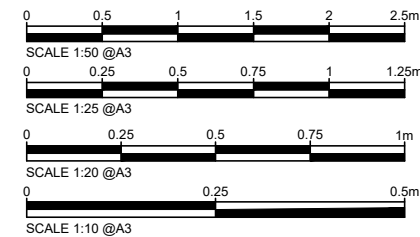

Revision	Date	Description	Drawn	ZE
-	13.09.24	First Issue		
architects project managers cost consultants 				
2nd Floor 13 Swan Yard Islington, London N1 1SD T: 0203 637 8980				
Status				
PLANNING				
Client				
SAINSBURY'S				
Project Title				
HAMPTON WICK 59-61 HIGH STREET, KT1 4DG				
Drawing Title				
PROPOSED SIGNAGE DETAILS SITE REF: - 118165				
Project Number		Drawing Number		Revision
P_118165		P-215		-
Drawn	Checked	Scale	Date	
ZE	VA	AS SHOWN@A3	13.09.2024	
The content of this drawing is the property of JLA Limited and may not be copied in whole or part without formal consent.				